

Appendix 7-2

Site Specific Flood Risk Assessment

Crown Square Development, Galway

Site Specific Flood Risk Assessment

July 2019

Document Control

Document Number: 183-106-SSFRA

Revision	Description	Date	Prepared	Checked	Approved
R0	DRAFT	17/10/2018	D. Egan	D. Ryan	R. Winkel
PL0	Planning Issue	06/11/2018	D. Egan	D. Ryan	R. Winkel
PL1	SHD Planning Issue Phase 2	09/07/2019	D Egan	D Ryan	C O'Brien

Table of Contents

Document Control	i
Table of Contents.....	ii
1 Introduction	1
1.1 Background	1
1.2 Existing Site	1
1.3 Nature of Proposed Development	2
2 Relevant Guidance	4
2.1 The Planning System and Flood Risk Management Guidelines	4
2.2 Galway City Development Plan 2017-2023	5
2.3 Land Zoning.....	6
3 Flood Risk Identification	7
3.1 Overview of the Hydrology of the Area.....	7
3.2 Topographical & Walkover Survey	7
3.3 History of Flooding	8
3.4 Site Geology	9
3.5 Review of Historical Mapping.....	10
4 Flood Zone Assessment.....	11
4.1 Preliminary Flood Risk Assessment (PFRA) Mapping.....	11
4.2 CFRAMS	12
4.3 Review of Existing Surface Water Infrastructure	15
4.4 Estimate of Flood Zone	15
5 Flood Risk Assessment	17
5.1 Sources of Flooding	17
5.2 Flood Mitigation Measures	18
5.3 Flood Risk Management	18
6 Conclusion	18
Appendix A Proposed Site Layout	A-1
Appendix B Ground Levels & Topographic Survey	B-1
Appendix C Site Visit Images	C-1
Appendix D CFRAMS maps.....	D-1
Appendix E Existing Services	E-1

1 Introduction

1.1 Background

PUNCH Consulting Engineers were appointed by Crown Square Developments Limited. to carry out a Site Specific Flood Risk Assessment (SSFRA) for a proposed mixed-use development in Galway City. The development, which will consist of Residential and Commercial Space, a hotel and underground parking, is located between the Monivea Road and Tuam Road in Galway City.

1.2 Existing Site

The site is located North-East of Galway City Centre and is accessible from Connolly Avenue; refer to Figure 1 for site location. The Site is bounded to the South by the Monivea Road, to the West by Connolly Avenue and to the North and East by Industrial buildings. The site drains generally in a westerly direction from approximately 30.5m AOD on the Eastern side of the site to approximately 28m AOD on both the Monivea Road and Connolly Avenue on the Western edge of the site.

The River Corrib flows through Galway City where it joins the Atlantic Ocean. The Terryland River is located approximately 0.75km North West of the Site and flows in a South Westerly direction to meet the River Corrib downstream near Galway City Centre.



Figure 1: Site Location

1.3 Nature of Proposed Development

The proposed development has a plan area of approximately 5.117 hectares in total. Access to the development will be via the Monivea Road and Joyce's Road. The mixed-use development commenced on site in 2008. In late 2008, it was halted during the construction phase and has remained in a partially-constructed phase since that time. The current development is a continuation of the development abandoned in 2008.

The site has been stripped to create a double basement area over the entire site footprint, and this has been partially infilled with a two-storey concrete frame in one area of the site adjacent to Monivea Road. This existing structure is a significant element. There are also a large number of foundations poured in other areas of the site, and sections of basement slab.

The proposed development will be constructed in 2 phases. When completed, it will consist of Residential housing, Commercial Space, a hotel and underground car parking. The Site Layout is included in



Figure 2 and Appendix A.



Figure 2: Site Layout

The proposed finished floor levels of the buildings are approximately 30.8m AOD (please refer to Architects drawings for internal layout). Please note that the site will include a reduced podium in the middle of the site with a finished floor level of approximately 27m AOD. As part of the development, new surface water and foul water drainage networks will be constructed on site.

2 Relevant Guidance

2.1 The Planning System and Flood Risk Management Guidelines

In September 2008, “The Planning System and Flood Risk Management” Guidelines were published by the Department of the Environment, Heritage and Local Government in Draft Format. In November 2009, the adopted version of the document was published.

The Flood Risk Management Guidelines give guidance on flood risk and development. The guidelines recommend a precautionary approach when considering flood risk management in the planning system. The core principle of the guidelines is to adopt a flood risk sequential approach to managing flood risk and to avoid development in areas that are at risk. The sequential approach is based on the identification of flood zones for river and coastal flooding. The guidelines include definitions of Flood Zones A, B and C, as noted below. It should be noted that these do not take into account the presence of flood defences, as there remain risks of overtopping and breach of the defences.

Table 1: Flood Zone Designation.

Flood Zone	Type of Flooding	Annual Exceedance Probability (AEP)
Flood Zone A	Coastal	Less than a 1 in 200 year (0.5% AEP) event
	Fluvial	Less than a 1 in 100 year (1% AEP) event
Flood Zone B	Coastal	Greater than a 1 in 200 (0.5% AEP) and less than 1:1000 (0.1% AEP) year event
	Fluvial	Greater than a 1 in 100 (1% AEP) and less than 1:1000 (0.1% AEP) year event
Flood Zone C	Coastal	Greater than a 1 in 1000 (0.1% AEP) year event
	Fluvial	Greater than a 1 in 1000 (0.1% AEP) year event

Once a flood zone has been identified, the guidelines set out the different types of development appropriate to each zone. Exceptions to the restriction of development due to potential flood risks are provided for through the use of the **Justification Test**, where the planning need and the sustainable management of flood risk to an acceptable level must be demonstrated. This recognises that there will be a need for future development in existing towns and urban centres that lie within flood risk zones, and that the avoidance of all future development in these areas would be unsustainable.

A three-staged approach to undertaking a FRA is recommended:

1. **Flood Risk Identification (Stage 1)** - Identification of any issues relating to the site that will require further investigation through a Flood Risk Assessment;
2. **Initial Flood Risk Assessment (Stage 2)** - Involves establishment of the sources of flooding, the extent of the flood risk, potential impacts of the development and possible mitigation measures;
3. **Detailed Flood Risk Assessment (Stage 3)** - Assess flood risk issues in sufficient detail to provide quantitative appraisal of potential flood risk of the development, impacts of the flooding elsewhere and the effectiveness of any proposed mitigation measures.

This report addresses the requirements for Stage 1.

2.2 Galway City Development Plan 2017-2023

Policies relating to flood risk within the Galway City Development Plan 2017-2023 are outlined in Policy 9.3. The relevant excerpt from Section 9. 3 (Flood Risk Assessment) is copied below:

- Support, in co-operation with the OPW, the implementation of EU Flood Risk Directive (2007/60/EC), the Flood Risk Regulations (SI no. 122 of 2010), the DECLG and OPW Guidelines for Planning Authorities, the Planning System and Flood Risk Management (2009), updated/superseding legislation or departmental guidelines and have regard to the findings and relevant identified actions of the future Corrib Catchment Flood Risk Assessment and Management (CFRAM) Study, as the study progresses and incorporate these into the Development Plan, where appropriate;
- Have regard to the recommendations of the Strategic Flood Risk Assessment (SFRA) for the Galway City Development Plan 2017-2023 in the assessment of development in identified areas of flood risk;
- Restrict the location of structures other than structures with essential links to the waterway and public utilities within 10 metres of the River Corrib in G agricultural zoned lands;
- Protect and promote sustainable management and uses of water bodies and watercourses from inappropriate development, including rivers, streams, associated undeveloped riparian strips, wetlands and natural floodplains;
- Ensure flood risk is addressed in any future local area plans, framework plans and masterplans in the city and have regard to the findings of the Strategic Flood Risk Assessment for Three Local Area Plans 2012 in the preparation of LAPs for Ardaun, Headford Road area, and Murrough;
- Require a site-specific Flood Risk Assessment (FRA) for planning applications in identified areas at risk of flooding, where appropriate, in accordance with the recommendations of the Strategic Flood Risk Assessment (SFRA) for the Galway City Development Plan 2017-2023;
- Facilitate sustainable flood defence and coastal protection works in order to prevent flooding and coastal erosion, subject to environmental, visual and built heritage considerations;
- Ensure any proposal aimed at alleviating flooding will be subject to Appropriate Assessment in accordance with Article 6 of the EU Habitats Directive, where appropriate;
- Ensure the use of SUDS, sustainable urban drainage systems, wherever practical, in the design of development to reduce the rate and quantity of surface water run-off;
- Ensure new development, where appropriate, is designed and constructed to meet the flood design standards outlined under Section 11.27 Flood Risk Management and the recommendations of the Strategic Flood Risk Assessment (SFRA) for the Galway City Development Plan 2017-2023;
- Have regard to the findings of the OPW's Irish Coastal Protection Strategy Study (2013) of the west coast;
- Continue to protect the coastal area and foreshore and avoid inappropriate development in areas at risk of coastal erosion and/or would cause and escalate coastal erosion in adjoining areas;
- Protect and maintain, where feasible, undeveloped riparian zones and natural floodplains along the River Corrib and its tributaries.

Objectives

- Where development is proposed in identified flood risk areas under Western CFRAM, the type or nature of the development needs to be carefully considered and the potential risks mitigated and managed through on-site location, layout and design of the development to reduce flood risk to an acceptable level;
- Development shall have regard to the flood resilient design guidance and flood mitigation measures in the City Council's Strategic Flood Risk Assessment for Galway City Development Plan 2017-2023, the recommendations and best practice guidelines of Appendix B - addressing flood risk management in design of development of The Planning System and Flood Risk Management Guidelines for Planning Authorities (2009) and the Strategic Flood Risk Assessment for Three Local Area Plan Areas 2012;
- In identified flood risk areas, Flood Zone A or B, it will be necessary to carry out a Site-Specific Flood Risk Assessment (FRA), appropriate to the scale and nature of the development and the risks arising. Proposals shall demonstrate appropriate mitigation and management measures in the layout and design of development;

- *All proposed development must consider the impact of surface water flood risk in drainage design. Consideration should be given in the design of new development to the incorporation of SUDS. The drainage design should ensure no increase flood risk to the site or downstream catchment;*
- *Development proposals in identified flood risk areas shall consider and incorporate the potential impacts of climate change and residual risk into development layout and design;*
- *In areas of identified flood risk all developments including minor works and changes of use should include an appropriate level of FRA. This assessment must demonstrate that the development would not increase flood risk in the context of use, emergency access and infrastructure. Development should demonstrate principles of flood resilient design.*

2.3 Land Zoning

The land on which the development is proposed is currently zoned as “C2.1 - Industrial, enterprise, employment” in the Galway City Development Plan 2017-2023. The designation applies to lands “To provide for light industry and commercial uses other than those reserved in the CC zone”. The proposed development is considered to be in accordance with this land zoning.

3 Flood Risk Identification

3.1 Overview of the Hydrology of the Area

The existing hydrological environment around the site is characterised primarily by the Terryland River. The Terryland River is approximately 0.75 km to the North West of the proposed development. The river discharges to the River Corrib approximately 2km downstream of the site, see Figure 3.

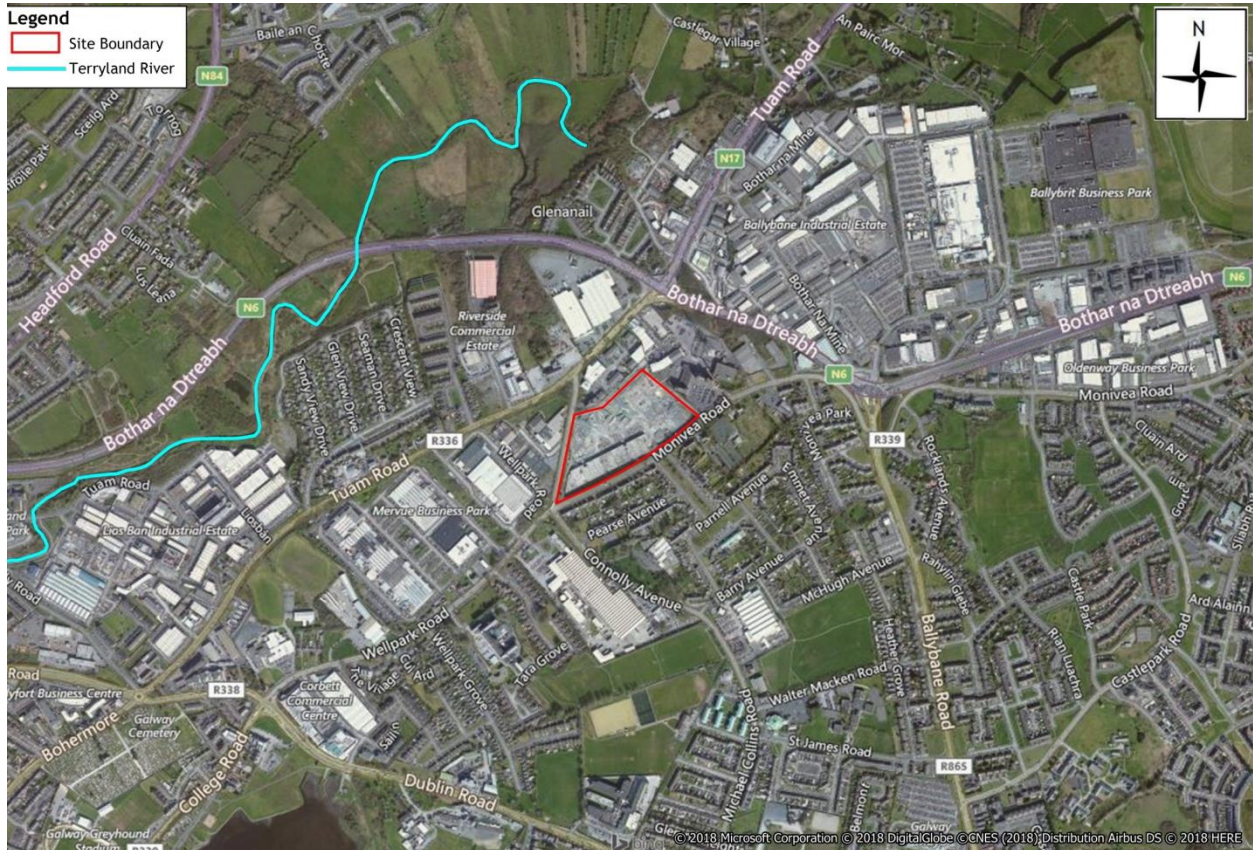

Figure 3: Hydrology of the area

3.2 Topographical & Walkover Survey

PUNCH Consulting Engineers visited the site of the proposed development on the 22nd of June 2018 to establish any potential sources of flooding, likely routes of floodwaters and key features of the site. The following points were established on site:

1. There is an existing 2-storey pre-cast concrete basement on site from the previous development back in 2008. This means there is a large excavation in the middle of the site;
2. The current excavation is supported on the Southern side of the site by a concrete retaining wall;
3. Large areas of the site are currently concreted and therefore impermeable. Ponding water was evident on these surfaces during the visit;
4. The previously excavated area of the site shows exposed rock towards the Eastern side of the site;
5. There is an existing stone wall topped with a railing running along part of the South boundary. There are also concrete block walls running along sections of the Northern and Eastern boundaries;
6. There is a compacted fill access ramp leading down into the basement excavation on site;
7. There is existing drainage running through the site.

A topographical survey was carried out by Arrigan Geo Surveyors in December 2004 and was reviewed as part of this study.

The site falls from a high point of circa 30.5m AOD in the middle of the Eastern side of the site to approximately 28m AOD at the Western boundary. The Terryland River flows in a South-Westerly direction approximately 0.75km from the site. Both banks of the river are approximately the same height where they pass near the site.

Note that the existing survey was carried out prior to the existing works commencing. The excavation on site is at a lower level. A Topographical survey is being commissioned to confirm all levels on site at the current time.

3.3 History of Flooding

The Office of Public Works (OPW) Flood Hazard Mapping website holds a record of historic flood events.

A review of this database indicated that there have been no reported incidences of flooding on the site (see Figure 4 and 0). There are some incidents identified in Galway City Centre (approximately 3km away) but there is no record of these incidences affecting the subject site. It is acknowledged that this is not a guaranteed complete record of all flood events in the area.

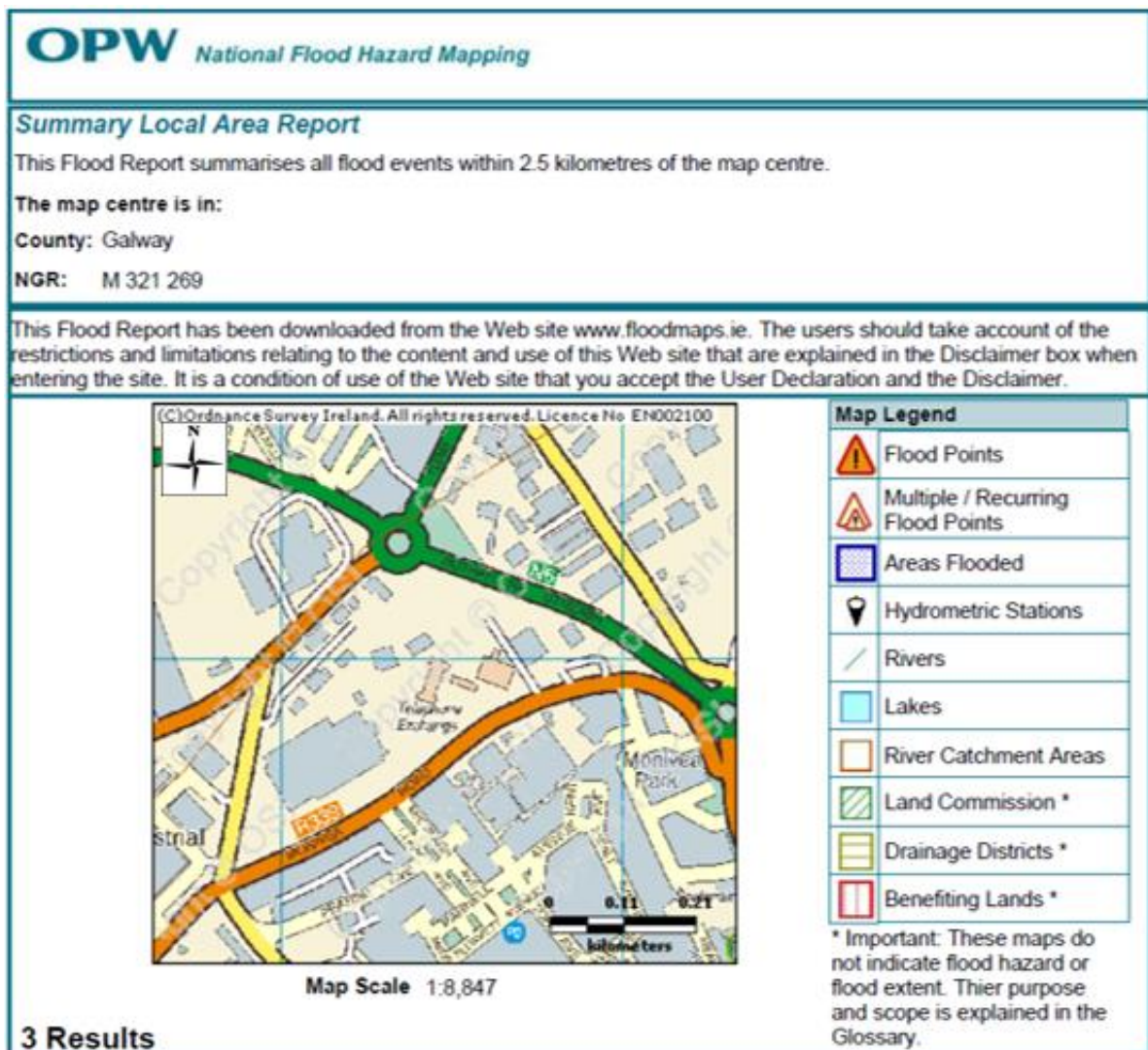

Figure 4: OPW Flood Maps indicate no records of flooding within the proposed development site

3.4 Site Geology

The geology of the site was reviewed using data from the Geological Survey of Ireland (available at www.gsi.ie). The location of the proposed development consists of Made Ground (Aqua)/Peaty mineral complexes (Grey). It is also noted that alluvium deposits (orange) are located North of the site which could suggest Historical Flooding along the route of the Terryland River.

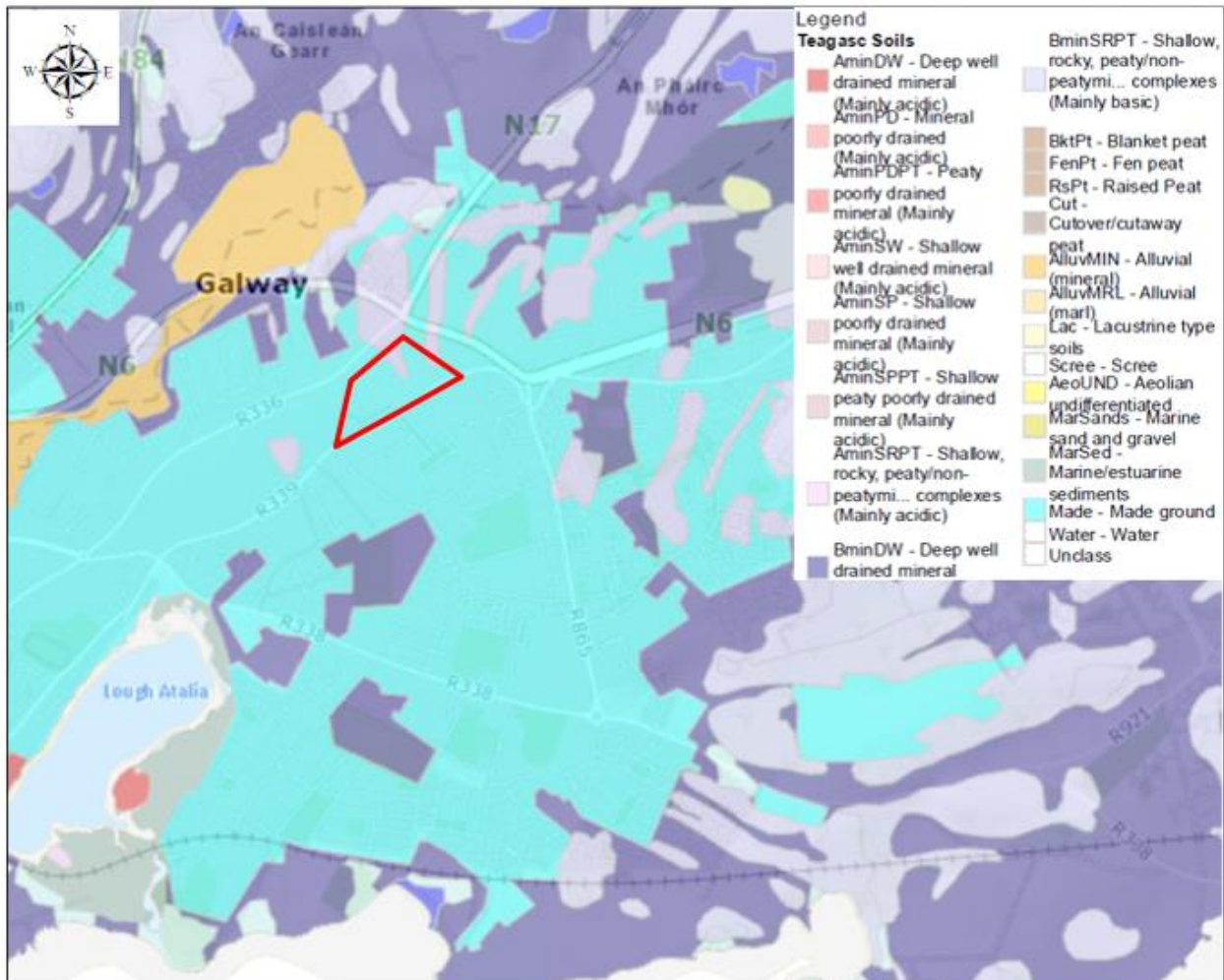

Figure 5: Site Geology (source Geological Survey of Ireland) - Site location identified in red

3.5 Review of Historical Mapping

The 6" (1837 - 1842) and the 25" (1888 - 1913) historical maps have been examined. Historical mapping is often a very useful source of information for assessing the flood history of an area. The historical maps examined do not indicate flooding in the area proposed for this development nor do they indicate the presence of wetlands within the site itself.



Figure 6: Extract for the 6" historical map (colour)



Figure 7: Extract for the 25" historical map

4 Flood Zone Assessment

4.1 Preliminary Flood Risk Assessment (PFRA) Mapping

The CFRAM (Catchment Flood Risk Assessment and Management) programme is a national programme which to-date has produced a series of Preliminary Flood Risk Assessments (PFRA), which covers the entire country, see: <http://www.cfram.ie/pfra/interactive-mapping>. It must be noted that these maps are indicative and the OPW note that “these maps are indicative and they have been developed using simple and cost-effective methods that are suitable for the PFRA. They should not be used for local decision-making or any other purposes without verification. Figure 8 is an extract from the PFRA mapping published for the area.

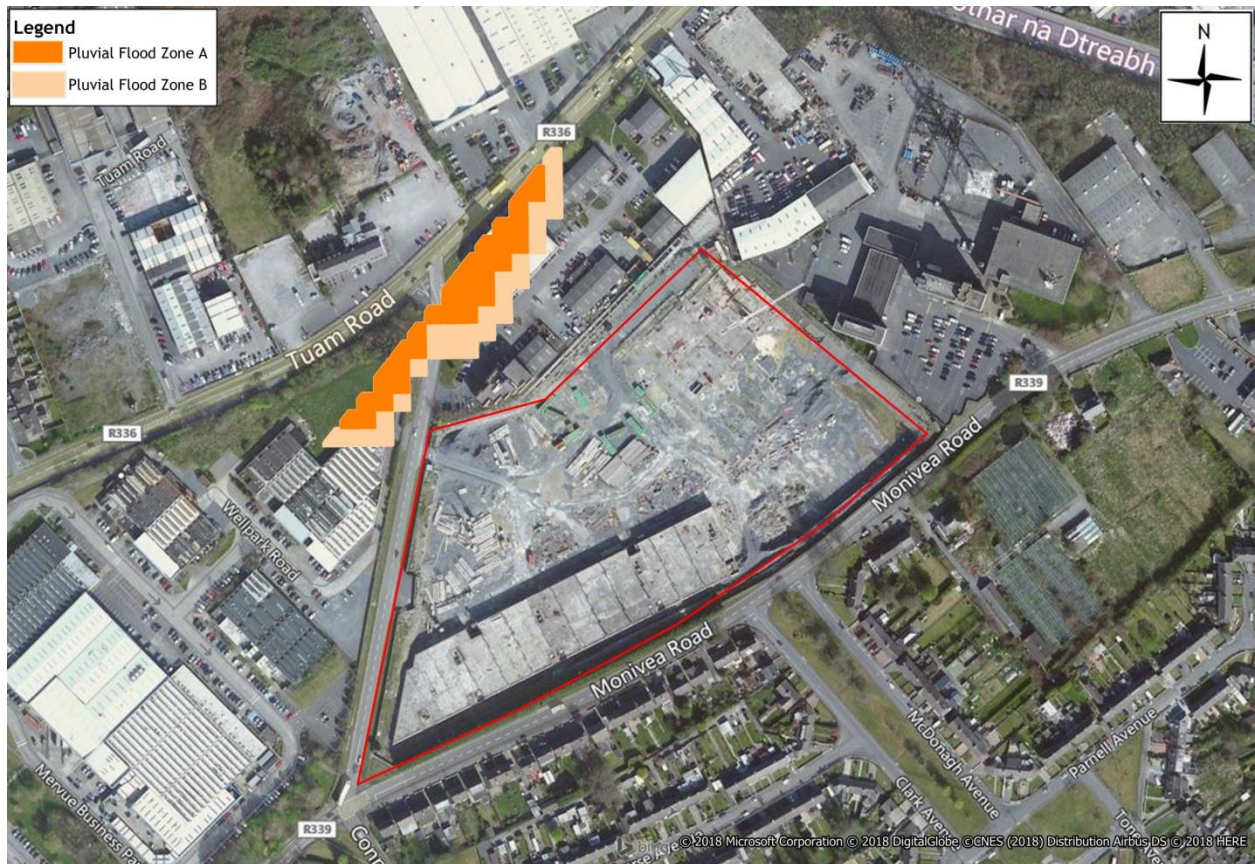

Figure 8: PFRA Mapping showing areas that may be at risk of flooding during extreme events (see 0 for full map)

As can be seen, the PFRA flood extents indicate that the site of the proposed development is not located within a flood zone. There is an area to the north of the proposed site noted as being at risk of pluvial flooding.

However, as noted previously, these maps are to be used as an initial assessment only. In the Galway City area, PFRA maps are superseded by more detailed CFRAMS mapping.

4.2 CFRAMS

The Western CFRAM study is an extensive study of flood risk in the West of Ireland and the OPW has published detailed flood hazard mapping based on the results of Western CFRAM study. This includes flood extent mapping for a number of return period events and flood depth mapping for each of the potential flood events.

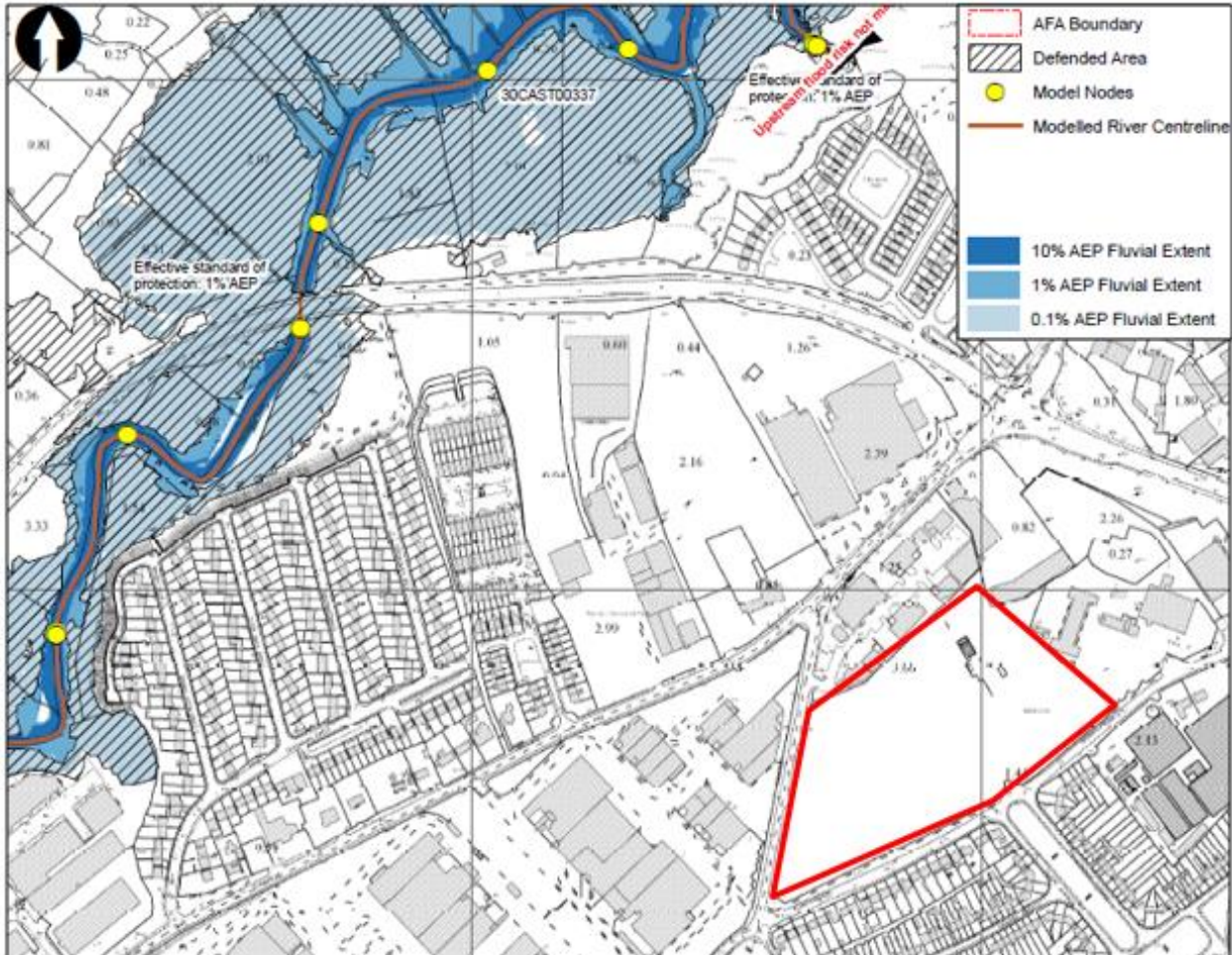

Figure 9 is an extract of the CFRAMS fluvial flood map for Galway City dated December 2017. The CFRAMS assessment is based on hydraulic modelling of the Terryland River. As can be seen from the map, the site isn't within the predicted flood zones and as such is considered to be located in Flood Zone C.

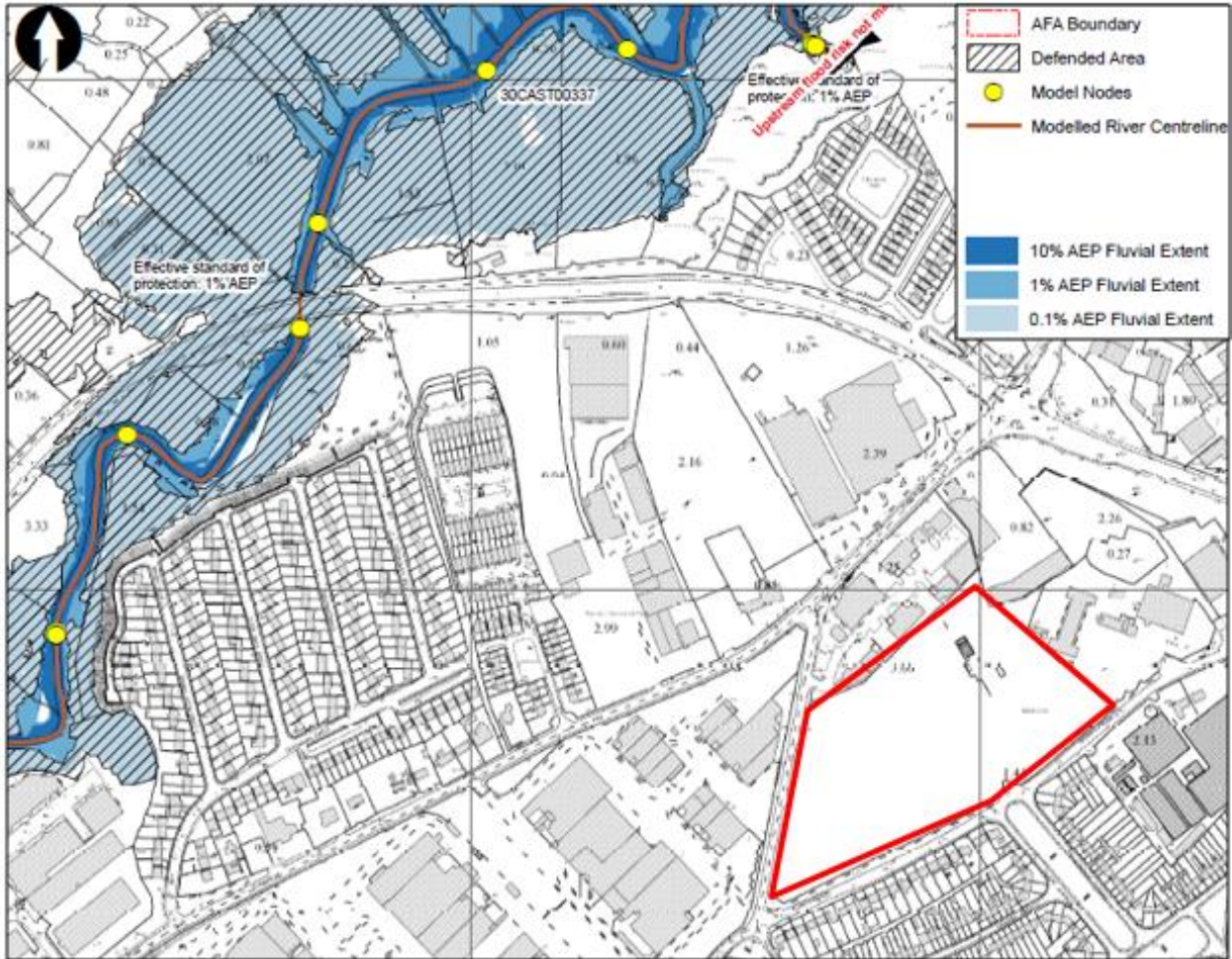

Figure 9: Extract from CFRAMS flood extent maps - site indicated in red (please see 0 for full map)

The CFRAMS maps also give an indication of flood depth for the 10%, 1% and 0.1% AEP events.

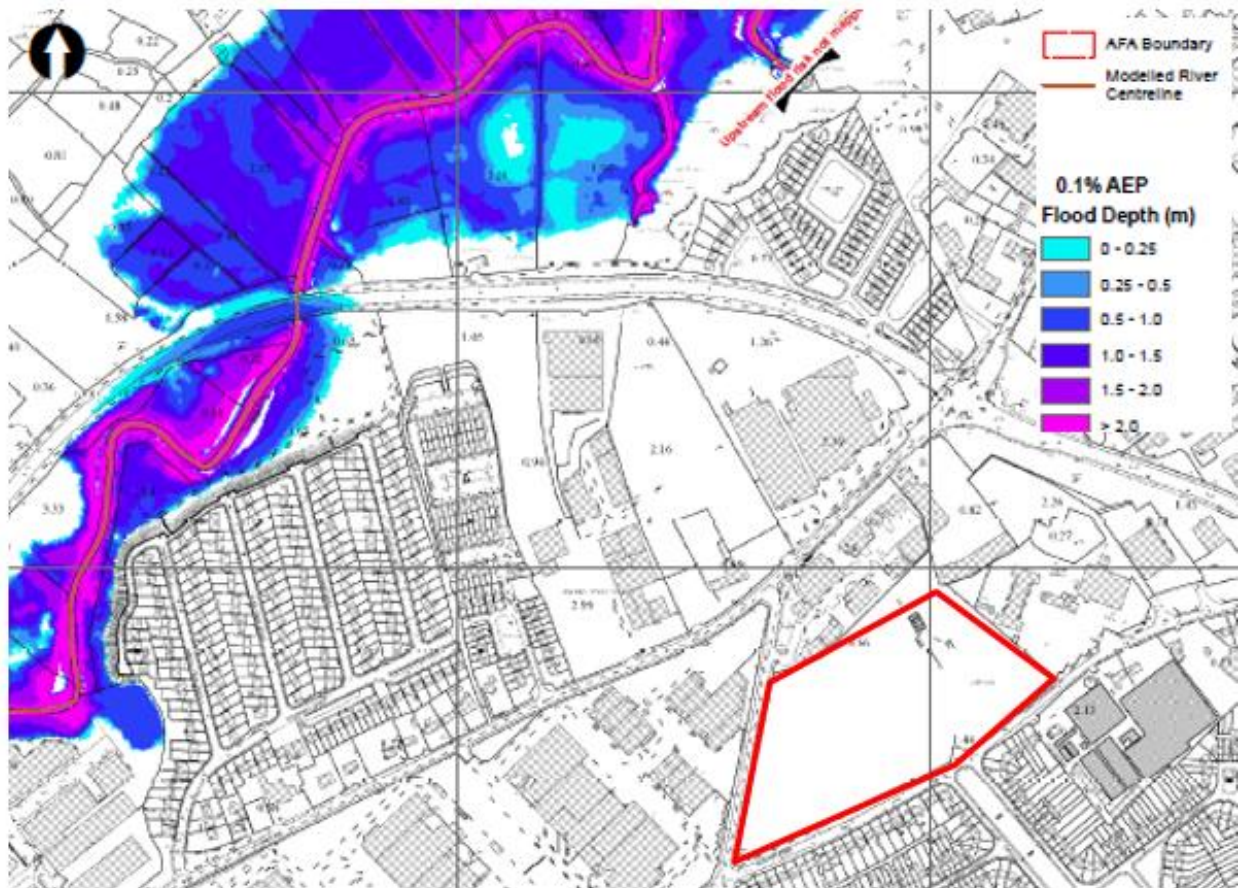

Figure 10 shows the flood depth within and surrounding the site of the proposed development. The site is not shown within a flood zone in the CFRAMS flood maps.

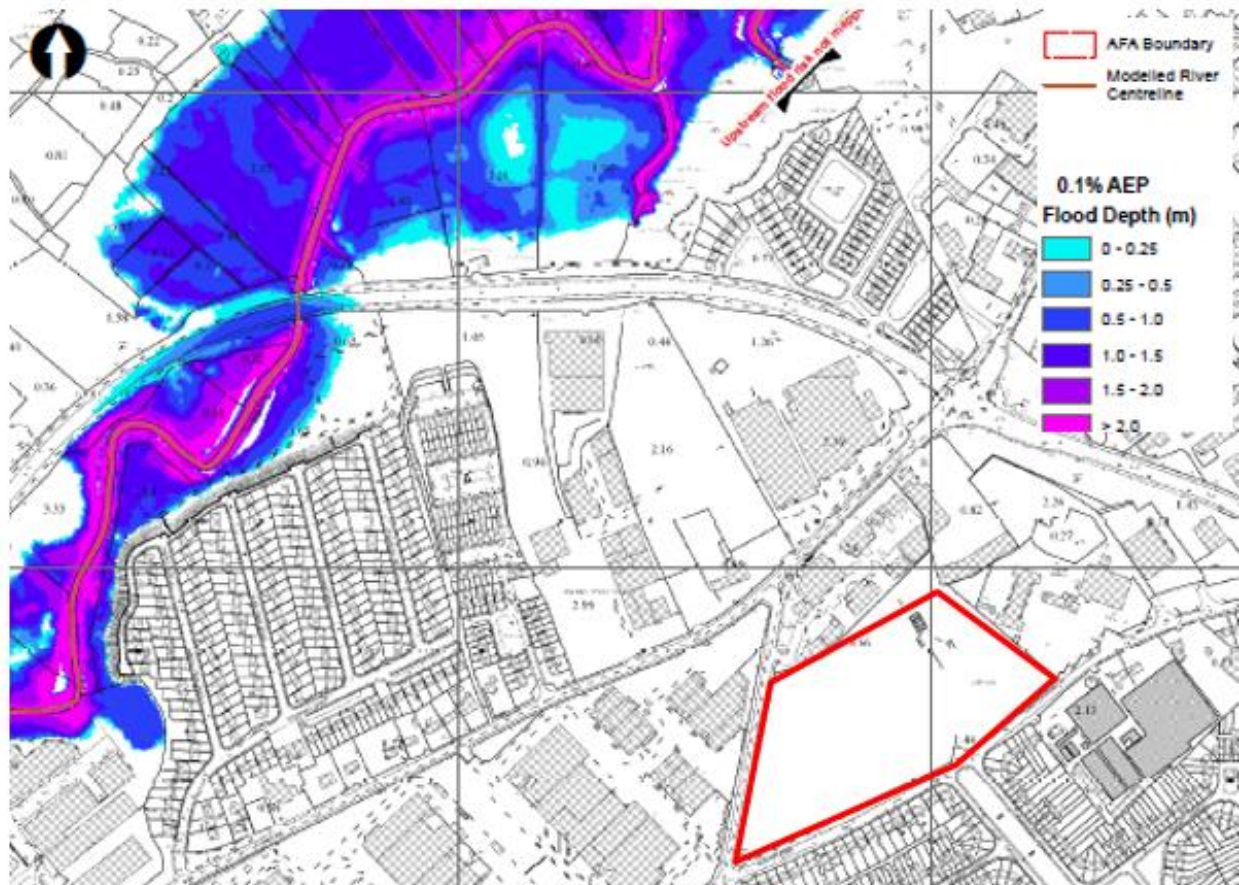

Figure 10: Extract from CFRAMS flood depth maps - site indicated in red (please see Appendix F for full map)

Although the site is shown to not be at risk of flooding there is still potential for pluvial flooding on the site. The proposed design includes a reduced podium area with a pumped surface water drainage system. In the event of a pump failure the surface water system in the podium will fill and flooding could occur in the podium depending on the level of rainfall at the time.

4.3 Review of Existing Surface Water Infrastructure

There is existing storm water drainage infrastructure near to the site. There is currently a 450 mm concrete sewer running along the Monivea road to the South of the site, and another sewer running along the Tuam road to the North of the site. These sewers service the existing residential and industrial buildings nearby.

It is proposed to discharge 70% of site surface water flows into the existing system on the Tuam Road and the remaining 30% into the system on the Monivea Road. Existing service drawings can be found in 0.

On-site attenuation is to be provided to restrict flows from the development to greenfield runoff rates of 2 litres per second per hectare across the site in accordance with the Galway City Development Plan, (see PUNCH Consulting Engineers Engineering Report and Drawings for further information).

4.4 Estimate of Flood Zone

From a review of all existing available flooding information, it is considered that the site of the proposed development is within Flood Zone C for Tidal, Pluvial and Fluvial flooding.

The primary risk of flooding to the site is the potential for the reduced podium to suffer pluvial flooding should the proposed pumped surface water drainage system for the podium fail. Section 5 will look at

the specific risks associated with this flooding as well as mitigation measures to reduce the risk to people and property in the same scenario.

5 Flood Risk Assessment

5.1 Sources of Flooding

When carrying out a flood risk assessment, one should consider all the potential flood risks and sources of flood water at the site. In general, the relevant flood sources are:

1. Fluvial Flooding

Fluvial flooding is the result of a river exceeding its capacity and excess water spilling out onto the adjacent floodplain. The site of the proposed development is not at risk from fluvial flooding.

2. Pluvial flooding

Pluvial flooding is the result of rainfall-generated overland flows which arise and “pond” on land before run-off can enter any watercourse or sewer. It is usually associated with high intensity rainfall. There are no locations on the site which are noted in the PFRA mapping as being at risk of pluvial flooding as shown in Figure 8. The proposed storm network (as part of this development) will be designed to ensure there is no pluvial flood risk to the development from extreme precipitation events.

The proposed development will include a reduced podium between the proposed car park and residential areas as mentioned previously. The proposed level of this podium will be 27.3 mAOD. The proposed storm network will deal with surface water from this area by pumping it North using a rising main where it will join the main line of the proposed storm network.

The main risk of flooding at the site comes from potential of a pluvial flood event at the reduced podium should the pump fail. There are proposed access points from the reduced podium into both the basement car park and nearby premises (likely to be commercial space). Potential flooding could also reach the basement level of the proposed hotel through the car park entrance (NOTE: the basement level of the hotel will comprise meeting rooms). Flooding in the podium therefore could potentially have adverse effects in the car park, hotel basement level and adjacent properties.

The proposed podium has been designed to offer the quickest access route between the underground car park (dedicated parking spaces will be provided for residential units) and the residential areas of the site. Flooding in the podium would interfere with this. However, access between the parking and the residential areas is possible through alternate routes on site.

3. Coastal Flooding

Coastal Flooding is the result of sea levels which are higher than normal and result in seawater overflowing onto the land during high tides or storm surges. CFRAMS mapping notes that while Some areas of Galway city are subject to coastal flooding, the proposed site isn't at risk form coastal flooding.

4. Groundwater Flooding

Groundwater flooding occurs when the level of the water stored in the ground rises as a result of prolonged rainfall. The study area is not identified as being at risk of groundwater flooding.

5.2 Flood Mitigation Measures

With reference to Section 4.2 above, a review of flood maps produced as part of the CFRAMS indicate that the site does not fall into Flood Zone A or B for coastal, fluvial or pluvial events. As mentioned there is a risk of a pluvial event occurring in the proposed reduced podium should the proposed pump fail. It should be noted that the surface water system itself will have a certain capacity in the event of a flood however it isn't considered for the purposes of this assessment. The following measures could be implemented to mitigate against such an event.

1. Entrance between the basement level of the hotel and the basement car park will be through a revolving door to minimise potential infiltration of surface water flow
2. Access between the basement car park and the proposed residential and commercial units can be achieved through the reduced podium. Alternate access will be provided between all these areas. This will prevent loss of access in the event of a pump failure.
3. The commercial units that can be accessed from the reduced podium will be designed with the potential flood risk in mind. Electrical sockets will be located high up on walls and floors and walls will be designed in impermeable materials. This will reduce the potential damage to the units should flooding occur. Access to these units could also incorporate revolving doors to reduce water infiltration.
4. Demountable Flood Barriers could be put in place at the entrances to properties fronting on to the reduced podium. These could be held on standby to be used in the event of the surface water pump failing.

5.3 Flood Risk Management

Flood risk management under the EU Floods Directive aims to minimise the risks arising from flooding to people, property and the environment. Minimising risks can be achieved through structural measures that block or restrict the pathways of flood waters, such as river defences or non-structural measures that are often aimed at reducing the vulnerability of people and communities such as flood warning, effective flood emergency response, or resilience measures for communities or individual properties.

Given that the proposed development is to include an impermeable reduced podium with a pumped surface water drainage system in that area, successful mitigation measures must be implemented to ensure that the proposed development is not at risk of flooding. Following the implementation of the mitigation measures outlined in Section 5.2 above, the flooding risk to the properties or to people will be minimised during an extreme flood event. In the event of a potential flood event to the podium, emergency access to all areas of the site can be achieved via other routes.

6 Conclusion

PUNCH Consulting Engineers were appointed by Crown Square Developments Limited to carry out a Site-Specific Flood Risk Assessment in accordance with the Flood Risk Management Guidelines for a proposed development in Galway City. The proposed development will be a mixed-use development incorporating commercial, residential and parking areas.

Flood maps produced as part of the CFRAM Study were consulted to establish the Flood Zone. These maps indicated that the site of the proposed development does not lie within Flood Zone A or Flood Zone B. The site is not affected by Fluvial, Pluvial or Coastal flooding.

The main risk of flooding is in the possibility of flooding occurring in the proposed reduced podium area should the pump in the proposed surface water drainage system for the podium fail. Appropriate measures have been taken to minimise the risk to properties or people in the event of a pump failure.

Appendix A Proposed Site Layout

ALL DIMENSIONS TO BE CHECKED ON SITE
 NO DIMENSIONS TO BE SCALED FROM THIS DRAWING
 DRAWING IS TO BE READ IN CONJUNCTION WITH RELEVANT CONSULTANTS DRAWINGS



1 Site_00_Site_Ground Floor
 1:500

REV	DATE	DESCRIPTION	MD	IC
P1	2019.06.20	ISSUED FOR INFORMATION	MD	IC
REV	DATE	DESCRIPTION	CKH	DRN

STATUS CODE DESCRIPTION
SUITABLE FOR INFORMATION

CLIENT
Crown Square Developments Ltd.

PROJECT
Crown Square Galway

PROJECT NUMBER
 950144

SCALE@ A1:
 1:500

DATE
 14/12/2018

DRAWN/CHECKED:
 IC/ MD

STATUS CODE: S2
 DRAWING NUMBER: CSG-HJL-ZZ-00-DR-A-0003
 REVISION: P1

Site Layout - L00 Ground Floor Level

Henry J Lyons
 Architecture + Interiors
 henryjlyons.com
 +353 1 888 3333
 info@henryjlyons.com
 51-54 Pearse Street
 Dublin D02 KA66

Appendix B Ground Levels & Topographic Survey

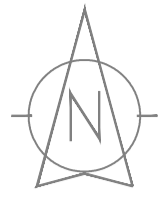

01

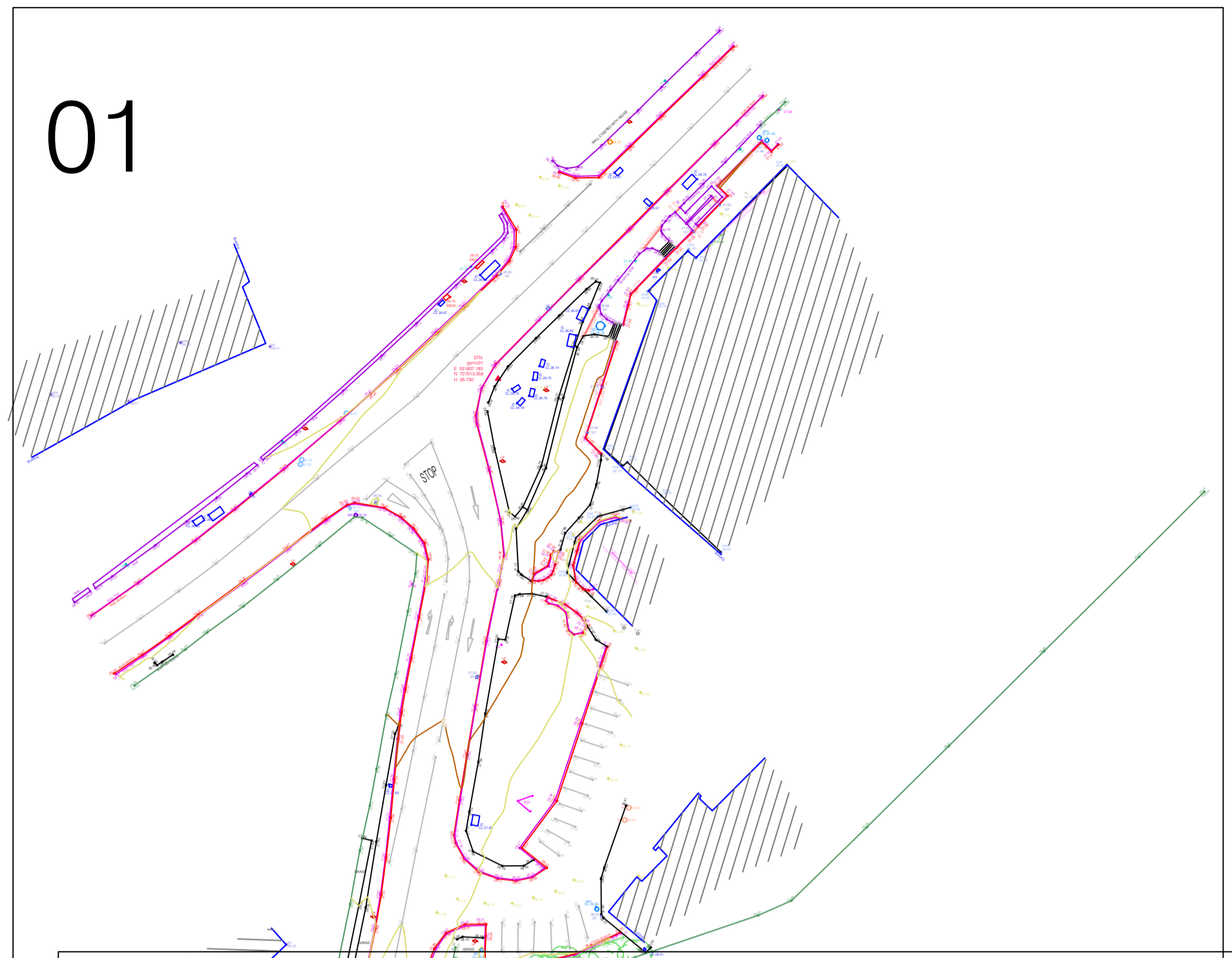

06

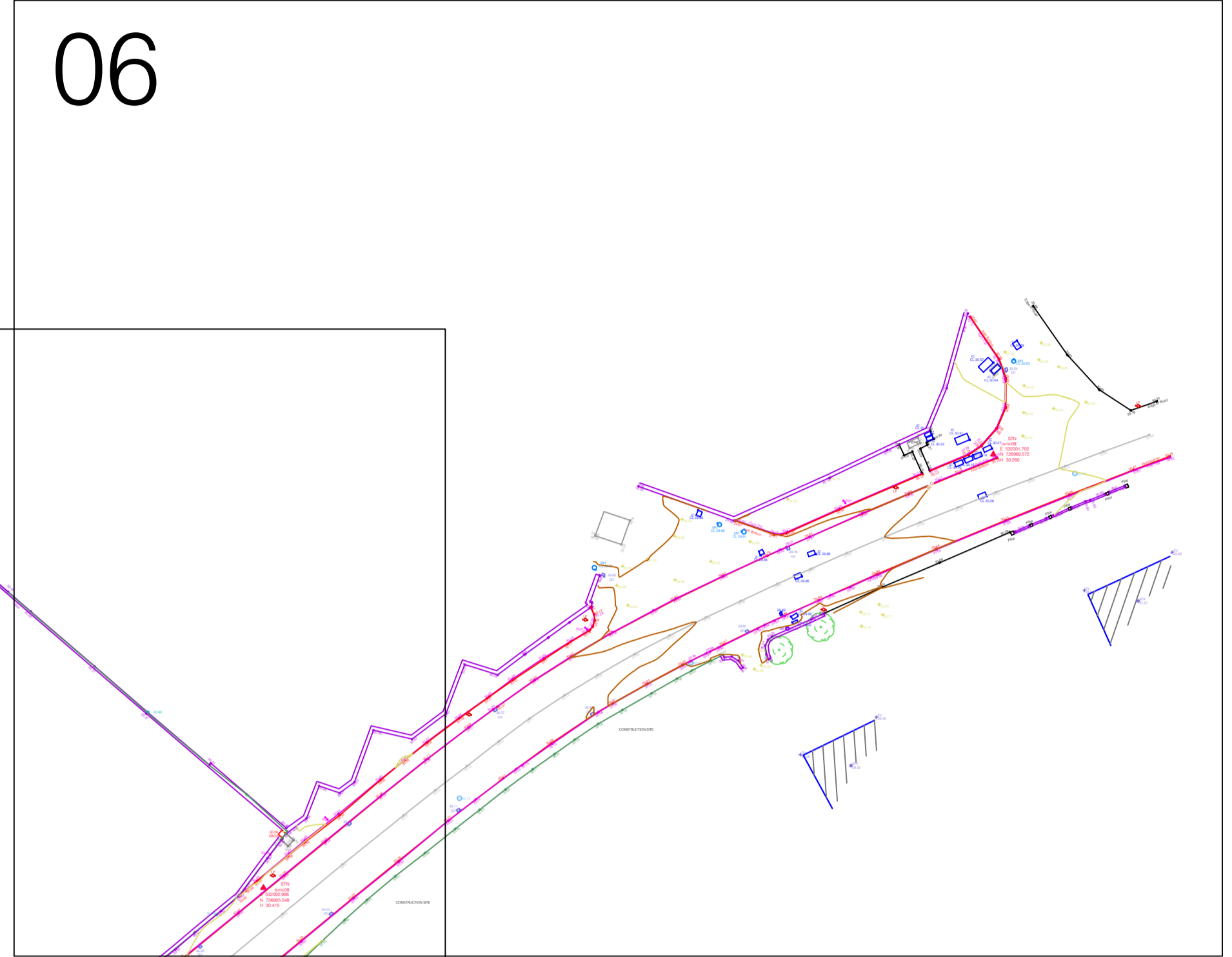

05

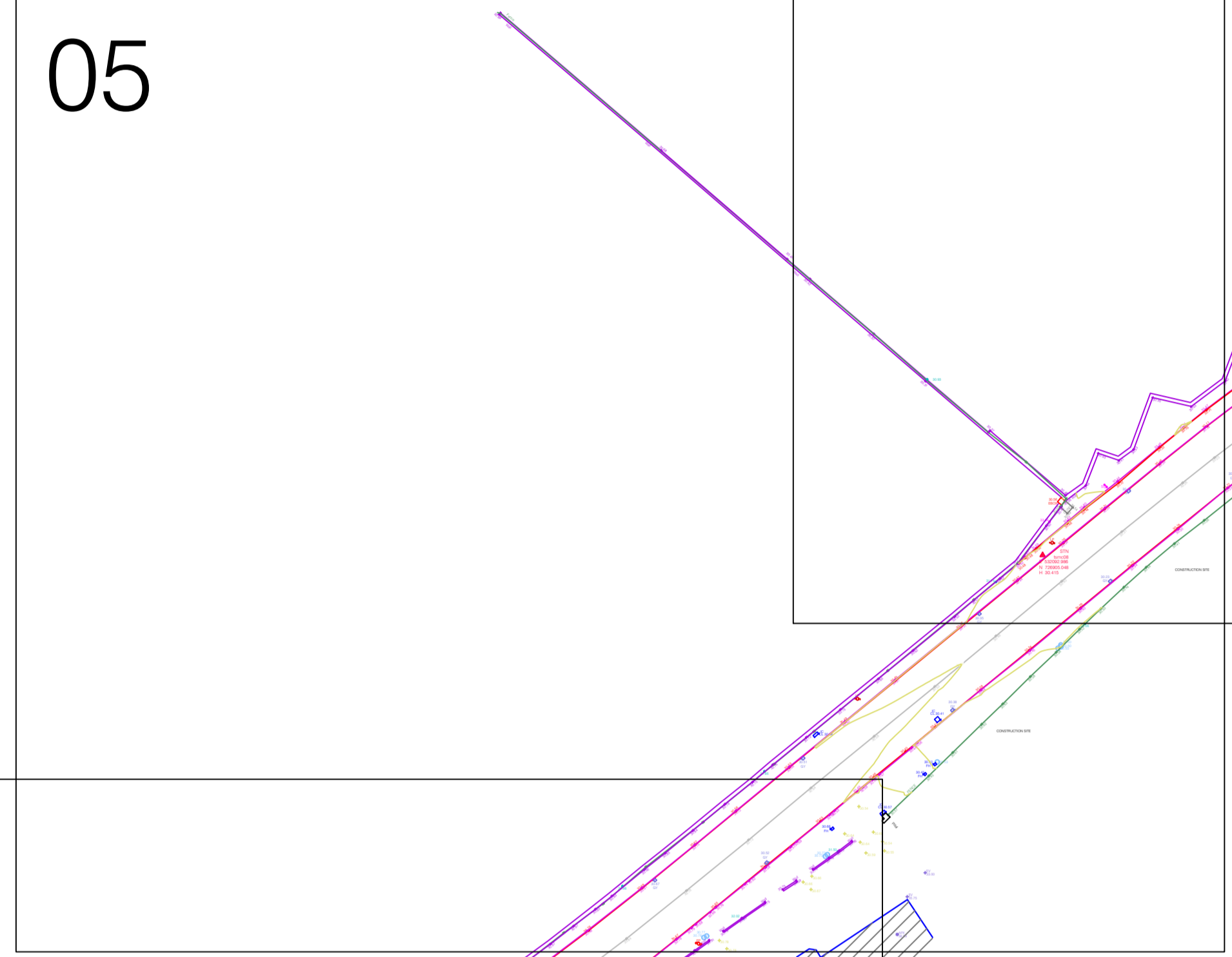

02

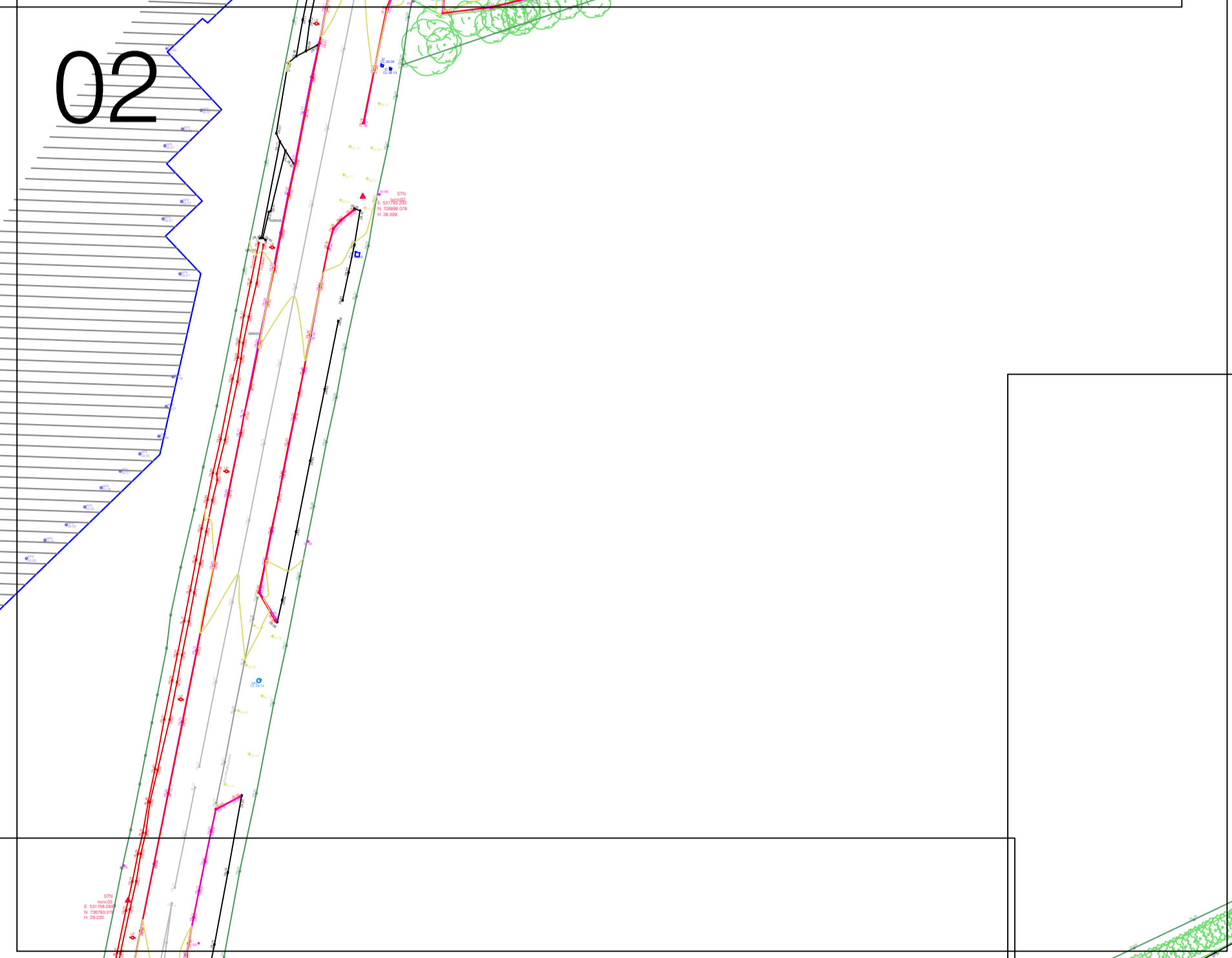

03

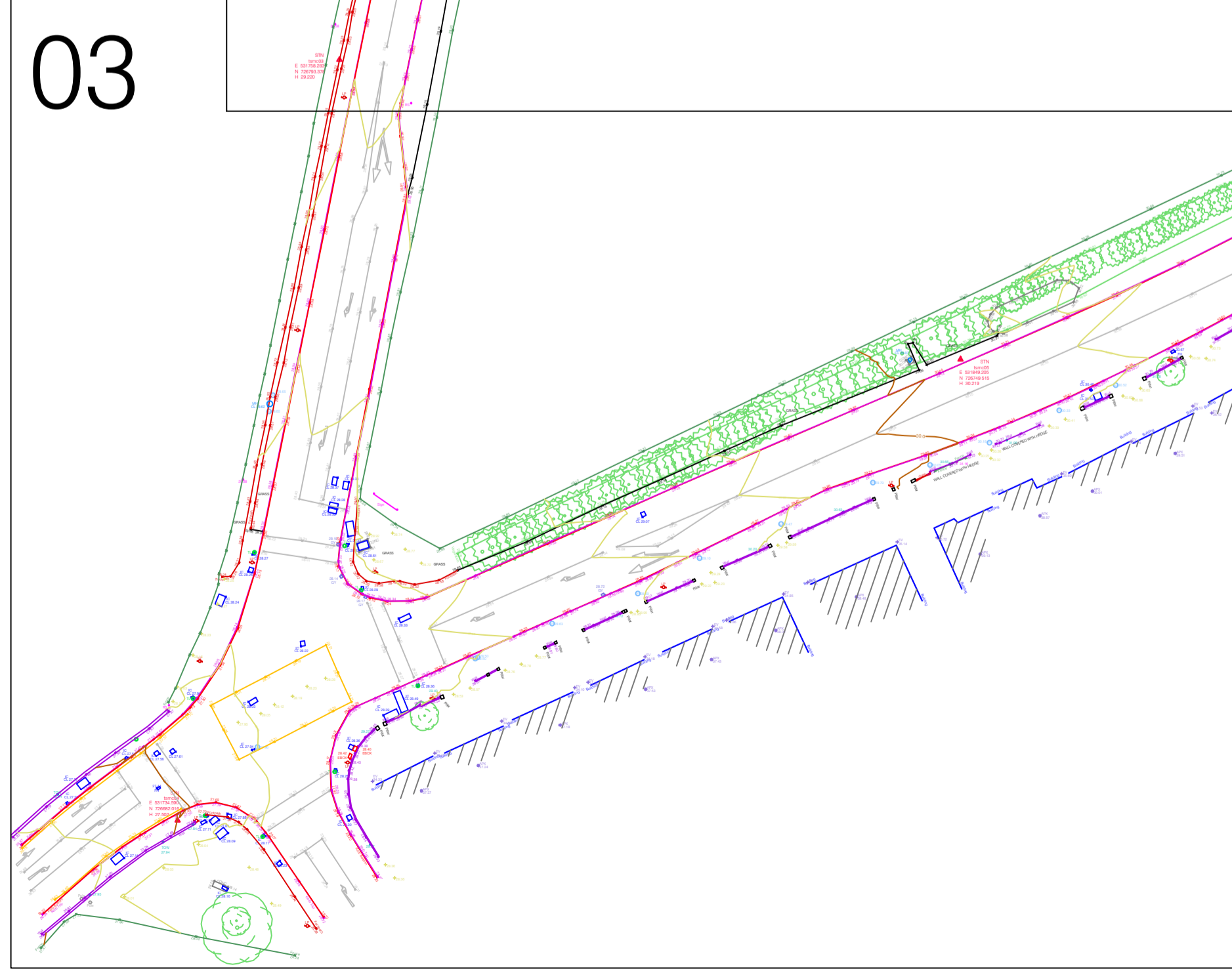

04

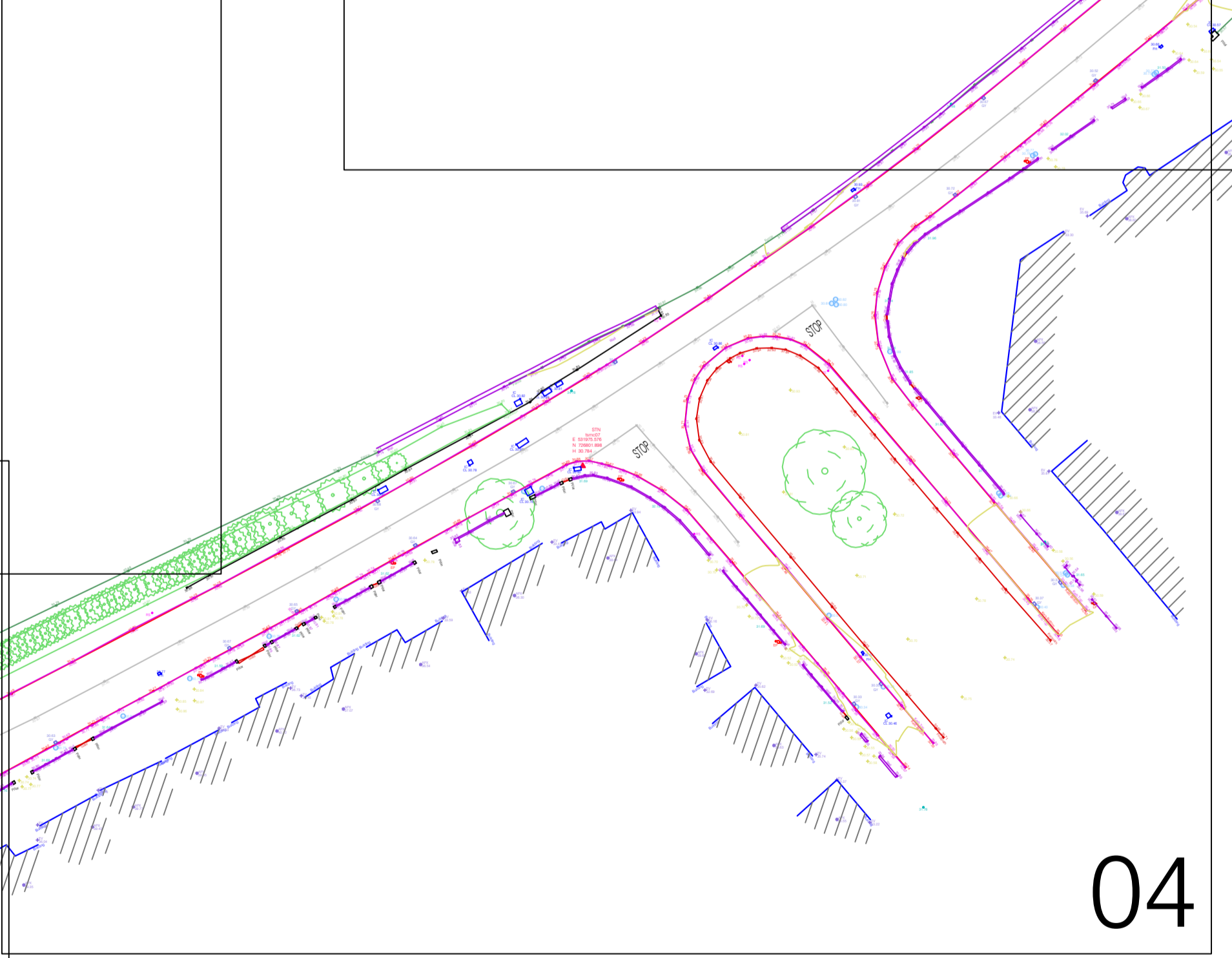

LEGEND
Street furniture & Services

Over Head Wires (LUAS) - Pylon ESB	Street Sign	Phone Box
Flowerbed	Beach Seat	Duct
Pipe	Ballot	Kiosk
Lit	BEA Beacon	Bus Stop
Barrier	CH Coalhole Cover	USG Car Park VMS
Pump	BH Bore Hole	Waste Bin
Trail Pit	EP Electricity Pole	Hydrant
Bus/Tram Shelter	TP Telegraph pole	Fire Hydrant
Postbox	OCS Pole	ESB Box
Valve - General	CCTV Camera Pole	ESB Inspection Cover
Water Valve	LP Lamp Post	Trucks Control Box
Gas Valve	FHM Foul Manhole	LUAS Technical Cabinet
Sluice Valve	SMH Surface Water MH	Ticket Vending Machine
Air Valve	MH Manholes	Water Meter Cover
Stop Cock	AC Air Conditioning Vents	Telecom Inspection Cover
C/P Post	ICU Services Inspection Cover	Monument / Toilets
Marker Post	KTC Traffic Inspection Cover	Tank Storage
Traffic Light	Cable TV Inspection Cover	Basement MH Cover & Pipe
Parking Meter	CSAT Inspection Cover	Dispersed Animal Mark
Plane Aerial Mark	MTL Inspection Cover	Stop for pole
Smart Card Validator	ESCS Inspection Cover	PP Pipe Protection
Unknown Valve	Roding Eye	Washout

Natural Features

Surface Change	Water Level	Golf
Land Drain	Crown Level	Fair Way
Bottom of Slope	Invert level	Green
Top of Slope	Bed Level	Tea Box
Ditch	Spotheight	Other
Water Edge / Lake / Pond		Survey Station
Hedge / Trees Drip Line / Vegetation		Photo point
Tree Coniferous	Tree Deciduous	Top of Tree

Built Features
Roads & Road Markings

Building	Fence	Floor Level
Edge of Road	Gate	Apex Height
Kerb Bottom	Road Centreline	Eaves Height
Kerb Top	Top of Wall	Parapet Height
Bridge Abutment	Hoarding	Step Elevation
Bridge Deck	Property Line	Step Elevation
Bridge Parapet	Road Bar	Concrete Pad
Building Facade	Top of Fence	Track
Footpath / Platform Train & Tram	Wall / Retaining Wall	
Damp Proof Course / Vege	Railway / Tram Rail / Gating / Ramp	
Bridge Pier / Wall & Gate Pile / LUAS Trackbed	Building Canopy / Roof / Overhang	
Cycleway / Private Landing Area		

Murphy Surveys Ltd. Disclaimer

The user or recipient of this survey data understands and acknowledges this data may be inaccurate or contain errors or omissions and the user or recipient assumes full responsibility for any risks or damages resulting from, arising from, or in connection with any use of or reliance upon data displayed herein. Although significant care has been exercised to produce surveys that satisfy survey accuracy standards, these surveys are only as accurate as the source data from which they were compiled. Although all reasonable steps have been taken to locate all features visible at the time of the survey, there is no guarantee that all will be shown on the drawing, as some above ground features may have obstructed the survey. Wherever possible, areas unable to be surveyed will be labelled as "UTS".

The Company shall not be liable for any inaccuracy of the data provided beyond the specified scale or accuracy, or for any matters resulting from their use for purposes other than that stated in the Contract. No liability shall attach to the Surveyor in respect of any consequential loss or damages suffered by the Client.

The Client must promptly notify the Company of any errors in mapping of which it becomes aware. If misleading, inaccurate or otherwise inappropriate information is brought to the Company's attention or the Company itself identifies any such impression or error in a survey, it shall use its reasonable endeavours to fix or remove it and if necessary in certain instances, the Company being on notice of any such misleading, inaccurate or otherwise inappropriate information, it will re-conduct the survey and reproduce the data to within the specified scale or accuracy.

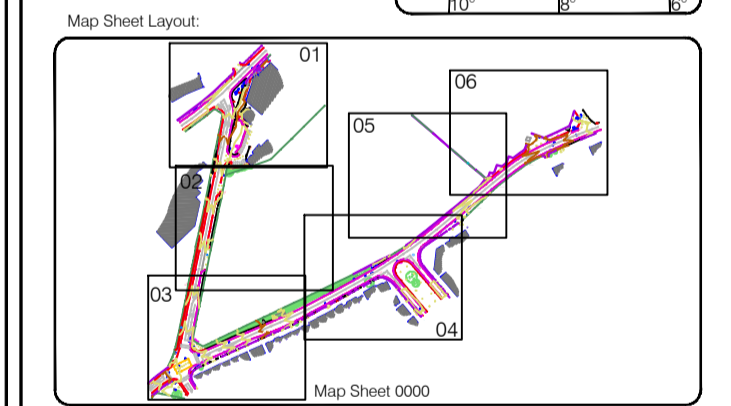
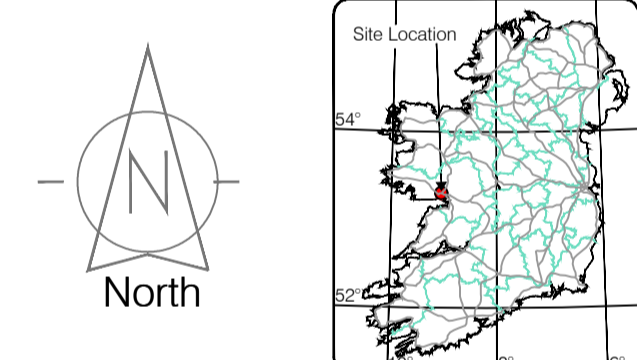

Drawn by: MC	Date: September 2018	Date: September 2018	Date: September 2018	Date: September 2018	Date: September 2018	Date: September 2018	Date: September 2018	Date: September 2018	Date: September 2018
Checked by: AM	Date: September 2018	Date: September 2018	Date: September 2018	Date: September 2018	Date: September 2018	Date: September 2018	Date: September 2018	Date: September 2018	Date: September 2018

SOCIETY OF CHARTERED SURVEYORS IRELAND

THE SURVEY ASSOCIATION FULL MEMBER

RICS

EUROPEAN GPR ASSOCIATION

murphy SURVEYS
GLOBAL CONSULTING SURVEYORS

Topographic surveys, Measured Building Surveys, Setting Out, As-Built Surveys, Hydrographic Surveys, Legal Mapping, Pipeline Surveys, Services Location, Ground Penetrating Radar, Laser Scanning, Rectified Photography

Kildare Cork Belfast Glasgow London

Head Office
Global House
Kilcullen Business Campus
Kilcullen Co. Kildare
Ireland

Phone: (+353) 045 484040
Fax: (+353) 045 484004
Email: info@murphysurveys.ie

Client:
Punch Consulting Engineers Limerick

Project:
Crown Square Development

Date: 25.09.2018 **Scale:** NSC@A1

Description:
Topographical Survey

Drawing Number: MSL26811_T_ITM_Rev_00

© Copyright 2018 MURPHY SURVEYS LTD

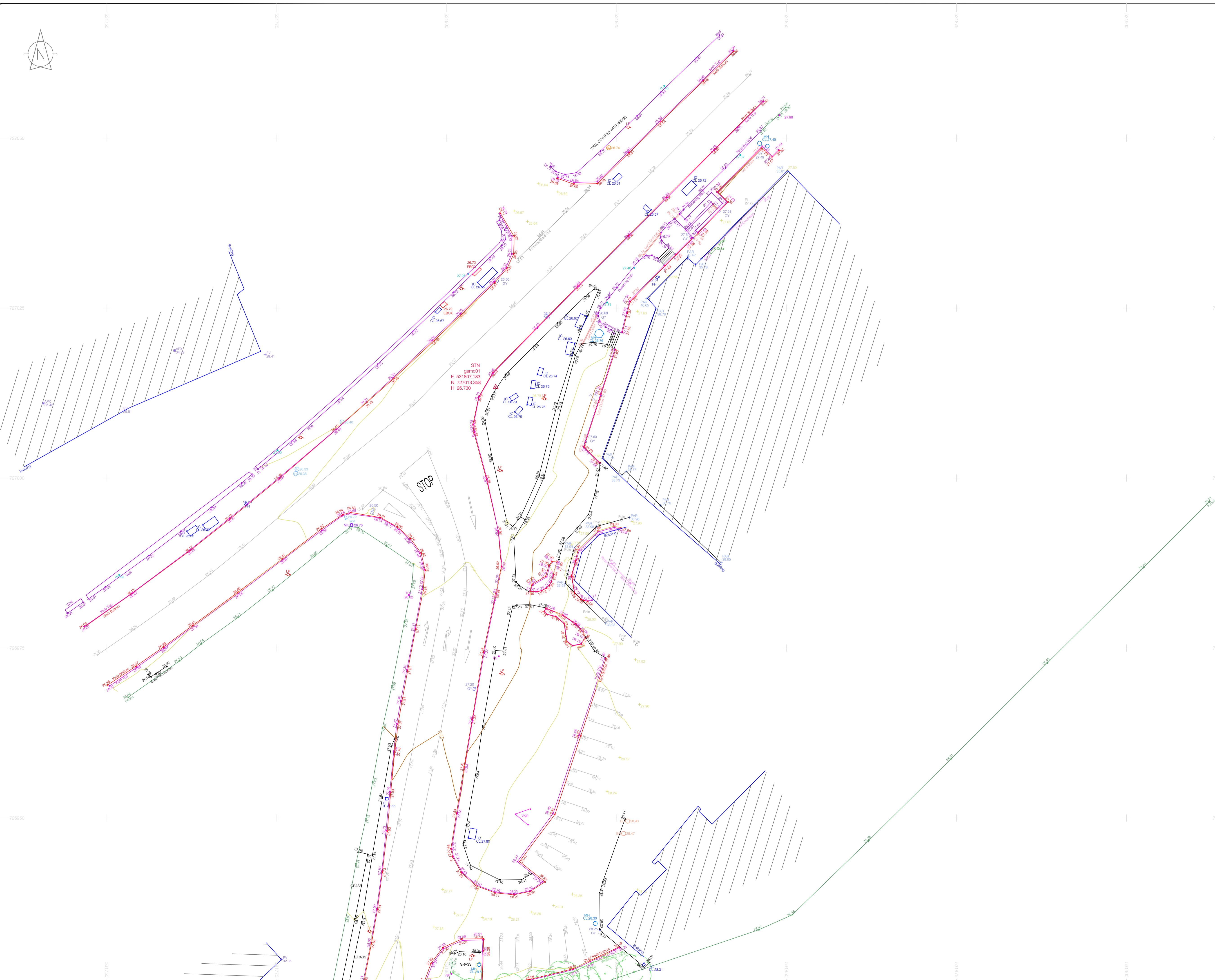
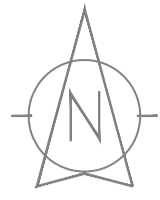

STN
gsmc01
E 531807.183
N 727013.358
H 26.730

LEGEND
Street furniture & Services

Over Head Wires (LUAS) - Pylon ESB	Beach Sign	Phone Box
Flowerbed	Beach Seat	Duct
Pipe	Bollard	Kiosk
Lit	Beacon	Bus Stop
Barrier	Coalhole Cover	USG Car Park Sign
Pump	Bore Hole	Waste Bin
Manhole	Electricity Pole	Hydrant
Bus/Traffic Shelter	Telegraph pole	Fire Hydrant
Postbox	OCS Pole	ESB Box
Water - General	CCTV Camera Pole	ESB Inspection Cover
Water Valve	Lamp Post	Trains Control Box
Gas Valve	Four Manhole	LUAS Technical Cabinet
Sluice Valve	Surface Water MH	Water Meter
Air Valve	Manholes	Water Meter Cover
Stop Cock	Air Conditioning Vents	Telecom Inspection Cover
C/P Post	Services Inspection Cover	Monument / Toilets
Marker Post	Traffic Inspection Cover	Tank Storage
Traffic Light	Cable TV Inspection Cover	Basement, MH, Cover & Pipe
Parking Meter	CDAT Inspection Cover	Dispersed Aerial Mark
Plane Aerial Mark	MFL Inspection Cover	Stop for pole
Smart Card Validator	Excise Inspection Cover	Stay for pole
Unknown Valve	Rodding Eye	Pipe Protection
		Washout

Natural Features

Surface Change	Water Level	Golf
Land Drain	Down Level	Fair Way
Bottom of Slope	Invert level	Green
Top of Slope	Bed Level	Tea Box
Ditch	Spotheight	Other
Water Edge / Lake / Pond		Survey Station
Hedge / Trees Drip Line / Vegetation		Photo point
Trees Coniferous	Trees Deciduous	Top of Tree

Built Features

Roads & Road Markings

Building	Fence	Floor Level
Edge of Road	Gate	Apex Height
Kerb Bottom	Road Centreline	Eaves Height
Kerb Top	Top of Wall	Parapet Height
Bridge Abutment	Hoarding	Soft Elevation
Bridge Deck	Property Line	Step Level
Bridge Parapet	Road Bar	Concrete Pad
Building Facade	Top of Fence	Track
Footpath / Platform Train & Tram	Wall / Retaining Wall	
Damp Proof Course / Veige	Railway / Tram Rail / Gating / Ramp	
Bridge Pier / Wall & Gate Pylon / LUAS Trackbed	Building Canopy / Roof / Overhang	
Cycleway / Private Landing Area		

Murphy Surveys Ltd. Disclaimer

The user or recipient of this survey data understands and acknowledges this data may be inaccurate or contain errors or omissions and the user or recipient assumes full responsibility for any risks or damages resulting from, arising from, or in connection with any use of or reliance upon data displayed herein. Although significant care has been exercised to produce surveys that satisfy survey accuracy standards, these surveys are only as accurate as the source data from which they were compiled. Although all reasonable steps have been taken to locate all features visible at the time of the survey, there is no guarantee that all will be shown on the drawing, as some above ground features may have obstructed the survey. Wherever possible, areas unable to be surveyed will be labelled as "UTS".

The Company shall not be liable for any inaccuracy of the data provided beyond the specified scale of accuracy, or for any matters resulting from their use for purposes other than that stated in the Contract. No liability shall attach to the Surveyor in respect of any consequential loss or damages suffered by the Client.

The Client must promptly notify the Company of any errors in mapping of which it becomes aware. If misleading, inaccurate or otherwise inappropriate information is brought to the Company's attention or the Company itself identifies any such imprecision or error in a survey, it shall use its reasonable endeavours to fix or remove it and if necessary in certain instances, the Company being on notice of any such misleading, inaccurate or otherwise inappropriate information, it will re-conduct the survey and reproduce the data to within the specified scale of accuracy.

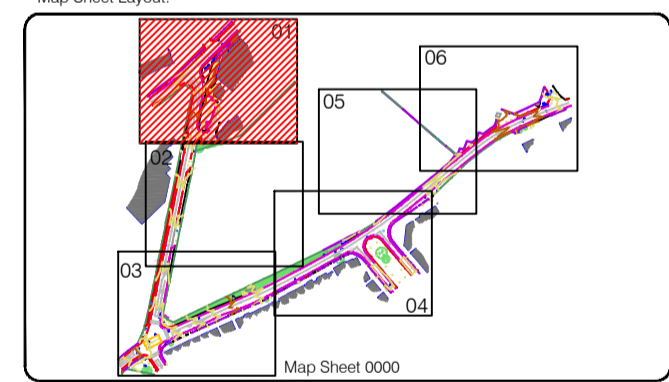
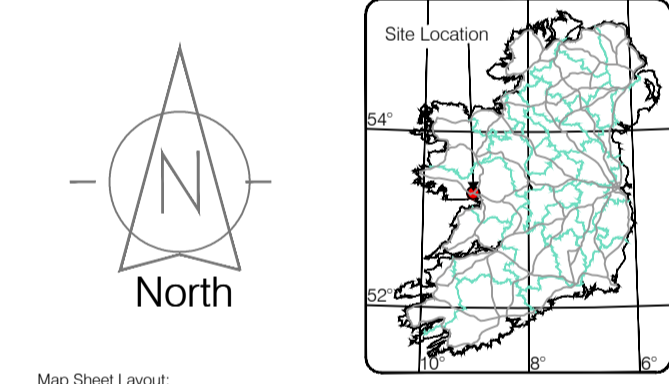

Drawn by: MC	Date: September 2018	Datum: Mean Head
Checked by: SF	Date: September 2018	Grid System: Irish National Grid
Checked by: AM	Date: 25.09.2018	UTM Zone: 29Q UTM

No	Date	Description
1	25.09.2018	First Drawing

SOCIETY OF CHARTERED SURVEYORS IRELAND

THE SURVEY ASSOCIATION FULL MEMBER

RICS

EUROPEAN GPR ASSOCIATION

murphy SURVEYS
GLOBAL CONSULTING SURVEYORS

Topographic surveys, Measured Building Surveys, Setting Out, As-Built Surveys, Hydrographic Surveys, Legal Mapping, Pipeline Surveys, Services Location, Ground Penetrating Radar, Laser Scanning, Aerial Photography

Kildare Cork Belfast Glasgow London

Head Office
Global House
Kilcullen Business Campus
Kilcullen Co. Kildare
Ireland

Phone: (+353) 045 484040
Fax: (+353) 045 484004
Email: info@murphysurveys.ie

Client:
Punch Consulting Engineers Limerick

Project:
Crown Square Development

Date: 25.09.2018 **Scale:** 1:250@A1

Description:
Topographical Survey

Drawing Number: MSL26811_T_ITM_Rev0_01

© Copyright 2018 MURPHY SURVEYS LTD

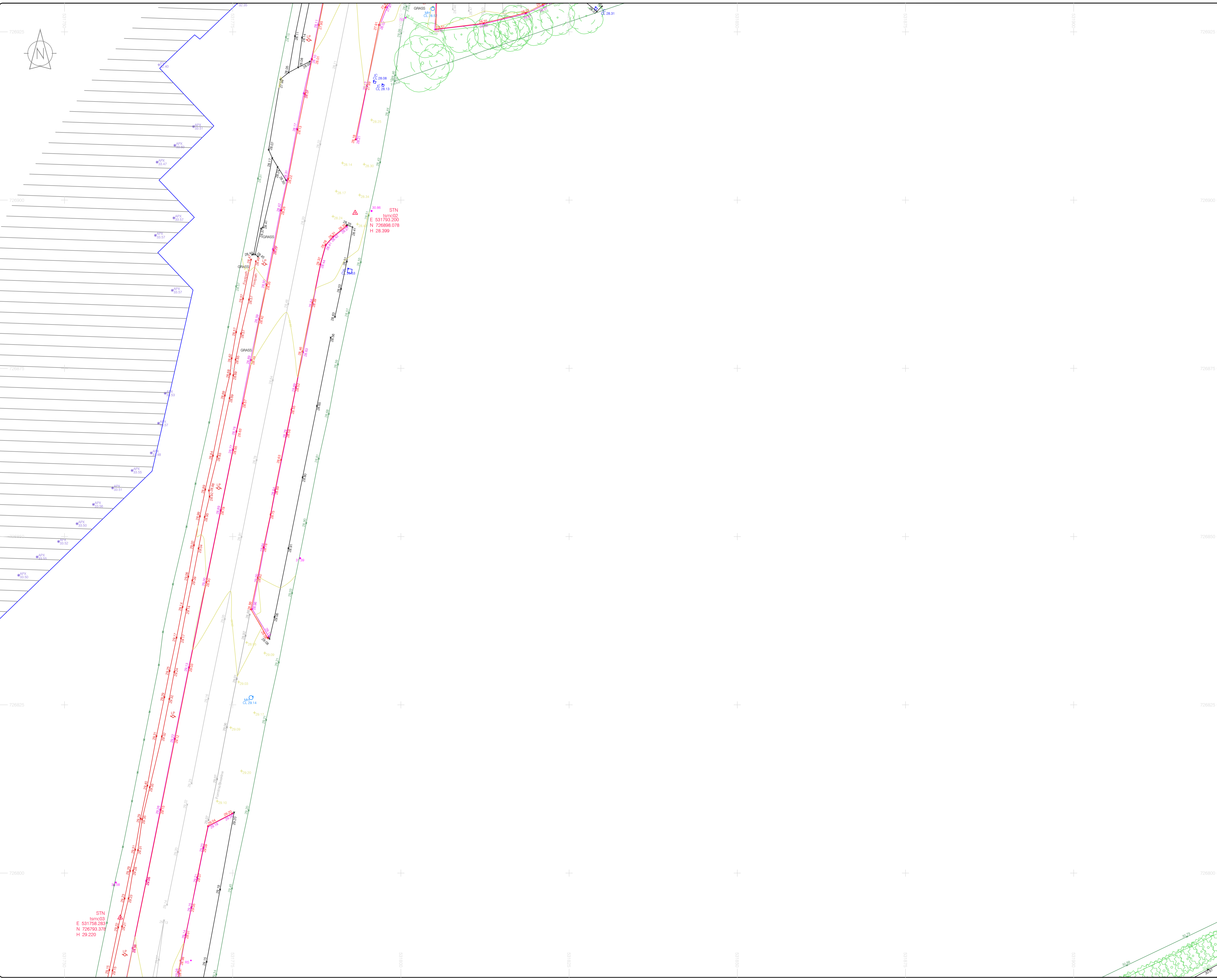

LEGEND

Street furniture & Services

Over Head Wires (LUAS) - Pylon ESB	Road Sign	Phone Box
Flowerbed	Beach Goal	Duct
Pipe	Kiosk	Gas Cover
Lt	Gully	P Box
Barrier	Waste Bin	USG Car Park Vase
Pump	Hydrant	Fire Hydrant
Manhole	Electricity Pole	Telegraph pole
Bus/Tram Shelter	Electricity Pole	Telegraph pole
Postbox	OCS Pole	ESB Box
Water - General	OCTV Camera Pole	ESB Inspection Cover
Water Valve	Lamp Post	Traffic Control Box
Gas Valve	Foul Manhole	LUAS Technical Cabinet
Sluice Valve	Surface Water MH	Ticket Vending Machine
Air Valve	Manholes	Water Meter Cover
Stop Cock	Air Conditioning Vents	Telecom Inspection Cover
C/P Post	Services Inspection Cover	Monument / Toilets
Marker Post	Traffic Inspection Cover	Tank Storage
Traffic Light	Cable TV Inspection Cover	Basement, MH, Cover & Pipe
Parking Meter	ESB Inspection Cover	ESB Aerial Mark
Pipe Access Mark	MU Inspection Cover	Stop for pole
Smart Card Validator	Electric Inspection Cover	Stay for pole
Unknown Valve	Rodding Eye	Washout

Natural Features

Surface Change	Water Level	Golf
Land Drain	Down Level	Fair Way
Bottom of Slope	Invert level	Green
Top of Slope	Bed Level	Tea Box
Ditch	Spotheight	Other
Water Edge / Lake / Pond	Spotheight	Survey Station
Hedge / Trees Drip Line / Vegetation	Spotheight	Photo point
Trees Coniferous	Tree Deciduous	Top of Tree

Built Features

Roads & Road Markings

Building	Fence	Floor Level
Edge of Road	Gate	Apex Height
Kerb Bottom	Road Centreline	Eaves Height
Kerb Top	Top of Wall	Parapet Height
Bridge Abutment	Hoarding	Soft Elevation
Bridge Deck	Property Line	Step Level
Bridge Parapet	Road Bar	Concrete Pad
Building Facade	Top of Fence	Track
Footpath / Platform Train & Tram	Wall / Retaining Wall	
Damp Proof Course / Veige	Railway / Tram Rail / Gating / Ramp	
Bridge Pier / Wall & Gate Pillar / LUAS Trackbed	Building Canopy / Roof / Overhang	
Cycleway / Private Landing Area		

Murphy Surveys Ltd. Disclaimer

The user or recipient of this survey data understands and acknowledges this data may be inaccurate or contain errors or omissions and the user or recipient assumes full responsibility for any risks or damages resulting from, arising from, or in connection with any use of or reliance upon data displayed herein. Although significant care has been exercised to produce surveys that satisfy survey accuracy standards, these surveys are only as accurate as the source data from which they were compiled. Although all reasonable steps have been taken to locate all features visible at the time of the survey, there is no guarantee that all will be shown on the drawing, as some above ground features may have obstructed the survey. Wherever possible, areas unable to be surveyed will be labelled as "UTS".

The Company shall not be liable for any inaccuracy of the data provided beyond the specified scale or accuracy, or for any matters resulting from their use for purposes other than that stated in the Contract. No liability shall attach to the Surveyor in respect of any consequential loss or damages suffered by the Client.

The Client must promptly notify the Company of any errors in mapping of which it becomes aware. If misleading, inaccurate or otherwise inappropriate information is brought to the Company's attention or the Company itself identifies any such impression or error in a survey, it shall use its reasonable endeavours to fix or remove it and if necessary in certain instances, the Company being on notice of any such misleading, inaccurate or otherwise inappropriate information, it will re-conduct the survey and reproduce the data to within the specified scale or accuracy.

Murphy Surveys Ltd. Disclaimer

The user or recipient of this survey data understands and acknowledges this data may be inaccurate or contain errors or omissions and the user or recipient assumes full responsibility for any risks or damages resulting from, arising from, or in connection with any use of or reliance upon data displayed herein. Although significant care has been exercised to produce surveys that satisfy survey accuracy standards, these surveys are only as accurate as the source data from which they were compiled. Although all reasonable steps have been taken to locate all features visible at the time of the survey, there is no guarantee that all will be shown on the drawing, as some above ground features may have obstructed the survey. Wherever possible, areas unable to be surveyed will be labelled as "UTS".

The Company shall not be liable for any inaccuracy of the data provided beyond the specified scale or accuracy, or for any matters resulting from their use for purposes other than that stated in the Contract. No liability shall attach to the Surveyor in respect of any consequential loss or damages suffered by the Client.

The Client must promptly notify the Company of any errors in mapping of which it becomes aware. If misleading, inaccurate or otherwise inappropriate information is brought to the Company's attention or the Company itself identifies any such impression or error in a survey, it shall use its reasonable endeavours to fix or remove it and if necessary in certain instances, the Company being on notice of any such misleading, inaccurate or otherwise inappropriate information, it will re-conduct the survey and reproduce the data to within the specified scale or accuracy.

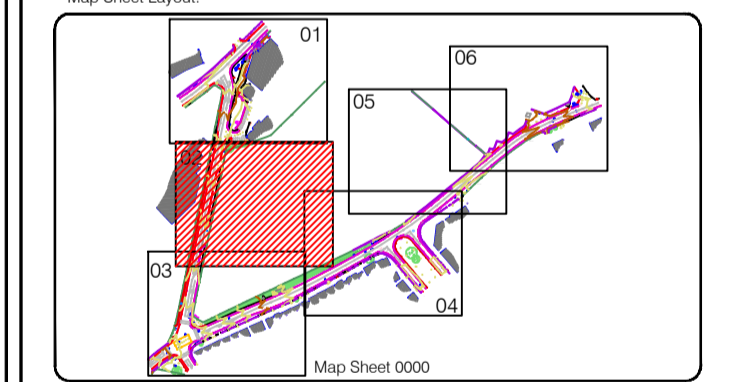
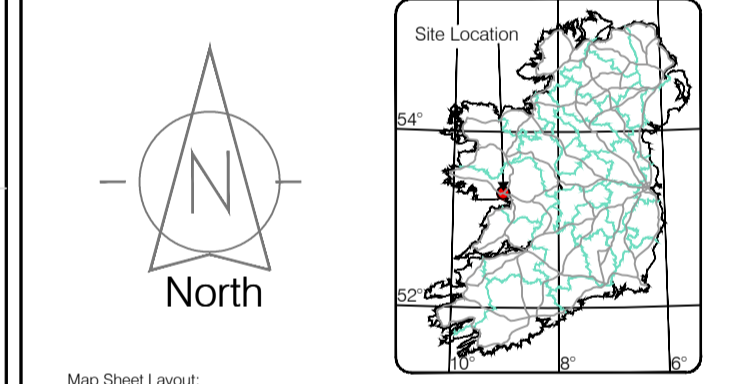

Drawn by: MC	Date: September 2018	Datum: Main Head
Checked by: SF	Date: September 2018	Grid System: Irish National Grid
Checked by: AM	Date: 25.09.2018	Irish National Grid
Revisions		
No	Date	Description
1	25.09.2018	First Drawing

GLOBAL CONSULTING SURVEYS

Topographic surveys, Measured Building Surveys, Setting Out, As-Built Surveys, Hydrographic Surveys, Legal Mapping, Pipeline Surveys, Services Location, Ground Penetrating Radar, Laser Scanning, Aerial Photography

Kildare Cork Belfast Glasgow London

Head Office
 Global House
 Kiccullen Business Campus
 Kiccullen Co. Kildare
 Ireland

Phone: (+353) 045 484040
Fax: (+353) 045 484004
Email: info@murphysurveys.ie

Client : Punch Consulting Engineers Limerick

Project : Crown Square Development

Date : 25.09.2018 **Scale :** 1:250@A1

Description : Topographical Survey

Drawing Number : MSL26811_T_ITM_Rev0_02

© Copyright 2018 MURPHY SURVEYS LTD

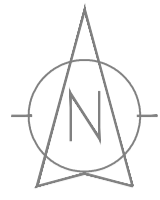

LEGEND
Street furniture & Services

Over Head Wires (LUAS) - Pylon ESB	Street Sign	Phone Box
Flowerbed	Beach Seat	Duct
Pipe	Beacon	Gas Cover
Lit	Beacon	Gas Cover
Barrier	Coalhole Cover	USG Car Park VMS
Pump	Bore Hole	Waste Bin
Trail Pit	Electricity Pole	Hydrant
Bus/Traffic Shelter	Telegraph pole	Fire Hydrant
Postbox	OCS Pole	ESB Box
Water - General	CCTV Camera Pole	ESB Inspection Cover
Water Valve	Lamp Post	Trails Control Box
Gas Valve	Foul Manhole	LUAS Technical Cabinet
Sluice Valve	Surface Water MH	Ticket Vending Machine
Air Valve	Manholes	Water Meter Cover
Stop Cock	Air Conditioning Vents	Telecom Inspection Cover
C/P Post	Services Inspection Cover	Monument / Toilets
Marker Post	Traffic Inspection Cover	Tank Storage
Traffic Light	Cable TV Inspection Cover	Basement MH, Cover & Pipe
Parking Meter	ESB Inspection Cover	Disused Aerial Mark
Plane Aerial Mark	ESB Inspection Cover	Stop for pole
Smart Card Validator	ESB Inspection Cover	Spotlight
Unknown Valve	Rodding Eye	Washout

Natural Features

Surface Change	Water Level	Golf
Land Drain	Down Level	Fair Way
Bottom of Slope	Invert level	Green
Top of Slope	Bed Level	Tea Box
Ditch	Spotheight	Other
Water Edge / Lake / Pond		Survey Station
Hedge / Trees Drip Line / Vegetation		Photo point
Tree Contourous	Tree Deciduous	Top of Tree

Built Features

Roads & Road Markings

Building	Fence	Floor Level
Edge of Road	Gate	Apex Height
Kerb Bottom	Road Centreline	Eaves Height
Kerb Top	Top of Wall	Parapet Height
Bridge Abutment	Hoarding	Soft Elevation
Bridge Deck	Property Line	Step Level
Bridge Pier	Road Bar	Concrete Pad
Building Footprint	Top of Fence	Track
Footpath / Platform Train & Tram	Wall / Retaining Wall	
Damp Proof Course / Vege	Railway / Tram Rail / Gating / Ramp	
Bridge Pier / Wall & Gate Pillar / LUAS Trackbed	Building Canopy / Roof / Overhang	
Cycleway / Private Landing Area		

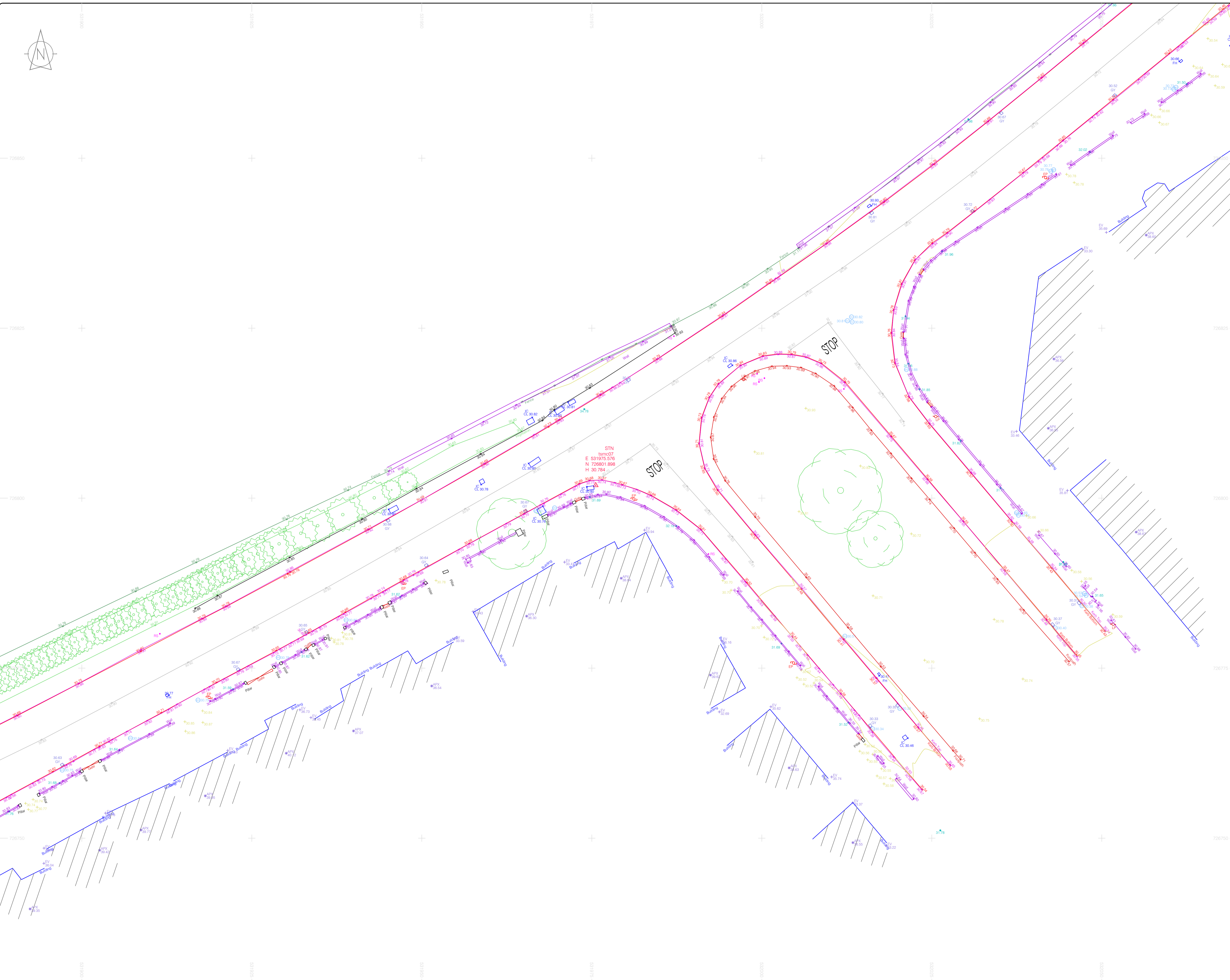

Murphy Surveys Ltd. Disclaimer

The user or recipient of this survey data understands and acknowledges this data may be inaccurate or contain errors or omissions and the user or recipient assumes full responsibility for any risks or damages resulting from, arising from, or in connection with any use of or reliance upon data displayed herein. Although significant care has been exercised to produce surveys that satisfy survey accuracy standards, these surveys are only as accurate as the source data from which they were compiled. Although all reasonable steps have been taken to locate all features visible at the time of the survey, there is no guarantee that all will be shown on the drawing, as some above ground features may have obstructed the survey. Wherever possible, areas unable to be surveyed will be labelled as "UTS".

The Company shall not be liable for any inaccuracy of the data provided beyond the specified scale or accuracy, or for any matters resulting from their use for purposes other than that stated in the Contract. No liability shall attach to the Surveyor in respect of any consequential loss or damages suffered by the Client.

The Client must promptly notify the Company of any errors in mapping of which it becomes aware. If misleading, inaccurate or otherwise inappropriate information is brought to the Company's attention or the Company itself identifies any such imprecision or error in a survey, it shall use its reasonable endeavours to fix or remove it and if necessary in certain instances, the Company being on notice of any such misleading, inaccurate or otherwise inappropriate information, it will re-conduct the survey and reproduce the data to within the specified scale or accuracy.

Map Sheet Layout:

Map Sheet 0000

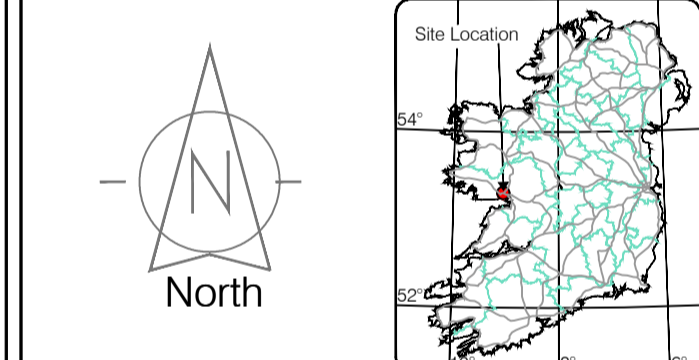

Drawn by: MC	Date: September 2018	Datum: Main Head
Checked by: SF	Date: September 2018	Grid System: Irish National Grid (ITM)
Checked by: AM	Date: 25.09.2018	

No	Date	Description
1	25.09.2018	First Drawing

murphy SURVEYS
GLOBAL CONSULTING SURVEYORS

Topographic surveys, Measured Building Surveys, Setting Out, Air-Photo Surveys, Hydrographic Surveys, Legal Mapping, Pipeline Surveys, Services Location, Ground Penetrating Radar, Laser Scanning, Aerial Photography

Kildare Cork Belfast Glasgow London

Head Office
Global House
Kilcullen Business Campus
Kilcullen Co. Kildare
Ireland

Phone: (+353) 045 484040
Fax: (+353) 045 484004
Email: info@murphysurveys.ie

Client:
Punch Consulting Engineers Limerick

Project:
Crown Square Development

Date: 25.09.2018 **Scale:** 1:250@A1

Description:
Topographical Survey

Drawing Number: MSL26811_T_ITM_Rev0_04

© Copyright 2018 MURPHY SURVEYS LTD

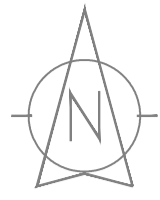

LEGEND			
Street furniture & Services			
Over Head Wires (LUAS) - Pylon ESB	Bus Stop	Bench Seat	Phone Box
Flowerbed	Bollard	Kiosk	Gas Cover
Pipe	Beacon	Grully	CP Box
Lit	BEA Beacon	USG Car Park Vase	Waste Bin
Barrier	CH Coalhole Cover	USG W	Hydrant
Pump	BH Bore Hole	USG W	Fire Hydrant
Trill Pit	EP Electricity Pole	USG W	Fire Hydrant
Bus/Tram Shelter	TP Telegraph pole	USG W	Fire Hydrant
Postbox	OCS OCTV Camera Pole	USG W	ESB Box
Water - General	CTV Camera Pole	USG W	ESB Inspection Cover
Water Valve	LP Lamp Post	USG W	Trucks Control Box
Gas Valve	FH Four Manhole	USG W	LUAS Technical Cabinet
Sluice Valve	SMH Surface Water MH	USG W	Ticket Vending Machine
Air Valve	MH Manholes	USG W	Water Meter Cover
Stop Cock	AC Air Conditioning Vents	USG W	Telecom Inspection Cover
C P Post	ICU Services Inspection Cover	USG W	Monument / Toilets
Marker Post	KTC Traffic Inspection Cover	USG W	Tank Storage
Traffic Light	CTV Cable TV Inspection Cover	USG W	Basement MH, Cover & Pipe
Parking Meter	GDH Inspection Cover	USG W	Dispersed Aerial Mark
Pipes Aerial Mark	MTL Inspection Cover	USG W	Stop for pole
Smart Card Validator	ECR Inspection Cover	USG W	Stay for pole
Unknown Valve	RE Rodding Eye	USG W	Pipe Protection
		USG W	Washout
Natural Features			
Surface Change	Water Level	FWY	Fair Way
Land Drain	Crown Level	GRSE	Green
Bottom of Slope	Invert level	TBOX	Tree Box
Top of Slope	Bed Level		Other
Ditch	Spotheight	ST	Survey Station
Water Edge / Lake / Pond			Photo point
Hedge / Trees Drip Line / Vegetation			
Tree Coniferous	Tree Deciduous		Top of Tree
Built Features			
Roads & Road Markings			
Building	Fence	Floor Level	
Edge of Road	Gate	Apex Height	
Kerb Bottom	Road Centreline	Eaves Height	
Kerb Top	Top of Wall	Parapet Height	
Bridge Abutment	Hoarding	Soft Elevation	
Bridge Deck	Property Line	Step Level	
Bridge Pier/Abut	Road Bar	Concrete Pad	
Building Facade	Top of Fence	Track	
Footpath / Platform Train & Tram	Wall / Retaining Wall		
Damp Proof Course / Vege	Railway / Tram Rail / Gating / Ramp		
Bridge Pier / Wall & Gate Pillar / LUAS Trackbed	Building Canopy / Roof / Overhang		
Cycleway / Private Landing Area			

Murphy Surveys Ltd. Disclaimer

The user or recipient of this survey data understands and acknowledges this data may be inaccurate or contain errors or omissions and the user or recipient assumes full responsibility for any risks or damages resulting from, arising from, or in connection with any use of or reliance upon data displayed herein. Although significant care has been exercised to produce surveys that satisfy survey accuracy standards, these surveys are only as accurate as the source data from which they were compiled. Although all reasonable steps have been taken to locate all features visible at the time of the survey, there is no guarantee that all will be shown on the drawing, as some above ground features may have obstructed the survey. Wherever possible, areas unable to be surveyed will be labelled as "UTS".

The Company shall not be liable for any inaccuracy of the data provided beyond the specified scale or accuracy, or for any matters resulting from their use for purposes other than that stated in the Contract. No liability shall attach to the Surveyor in respect of any consequential loss or damages suffered by the Client.

The Client must promptly notify the Company of any errors in mapping of which it becomes aware. If misleading, inaccurate or otherwise inappropriate information is brought to the Company's attention or the Company itself identifies any such impression or error in a survey, it shall use its reasonable endeavours to fix or remove it and if necessary in certain instances, the Company being on notice of any such misleading, inaccurate or otherwise inappropriate information, it will re-conduct the survey and reproduce the data to within the specified scale or accuracy.

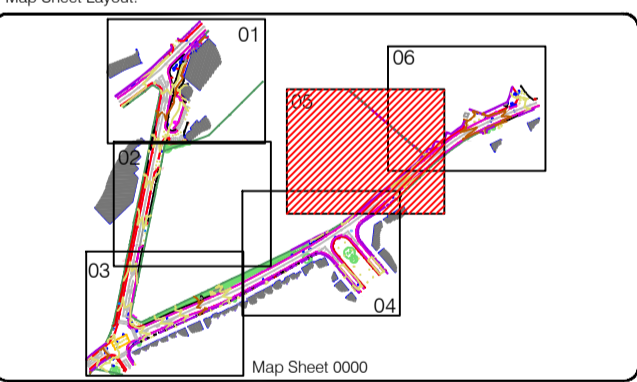
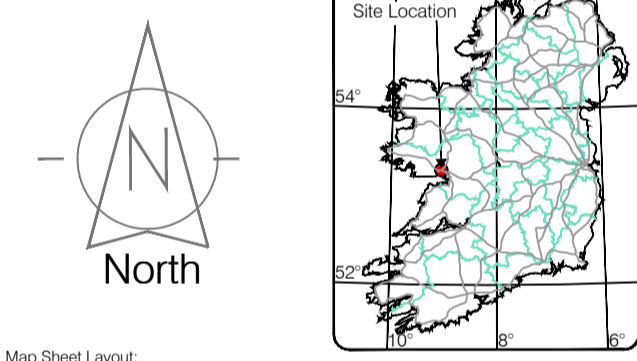

Drawn by: MC	Date: September 2018	Datum: Main Head
Checked by: SF	Date: September 2018	Grid System: Irish National Grid
Checked by: AM	Date: 25.09.2018	UTM Zone: 18N
Revisions		
No	Date	Description
1	25.09.2018	First Drawing

murphy SURVEYS
GLOBAL CONSULTING SURVEYORS

Topographic surveys, Measured Building Surveys, Setting Out, As-Built Surveys, Hydrographic Surveys, Legal Mapping, Pipeline Surveys, Services Location, Ground Penetrating Radar, Laser Scanning, Aerial Photography

Kildare Cork Belfast Glasgow London

Head Office
Global House
Kilcullen Business Campus
Kilcullen Co. Kildare
Ireland

Phone: (+353) 045 484040
Fax: (+353) 045 484004
Email: info@murphysurveys.ie

Client:	Punch Consulting Engineers Limerick
Project:	Crown Square Development
Date:	25.09.2018
Scale:	1:250@A1
Description:	Topographical Survey
Drawing Number:	MSL26811_T_ITM_Rev0_05

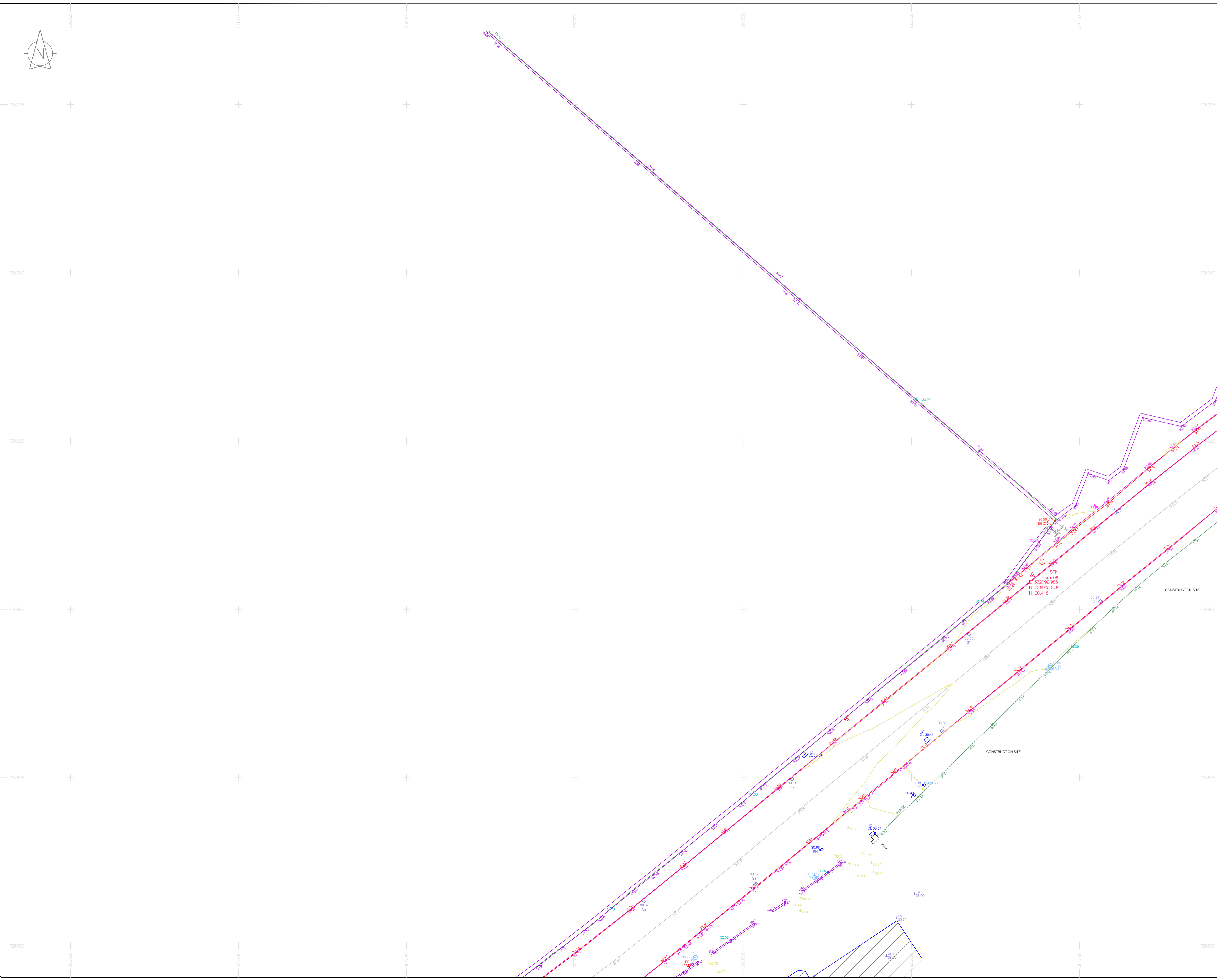

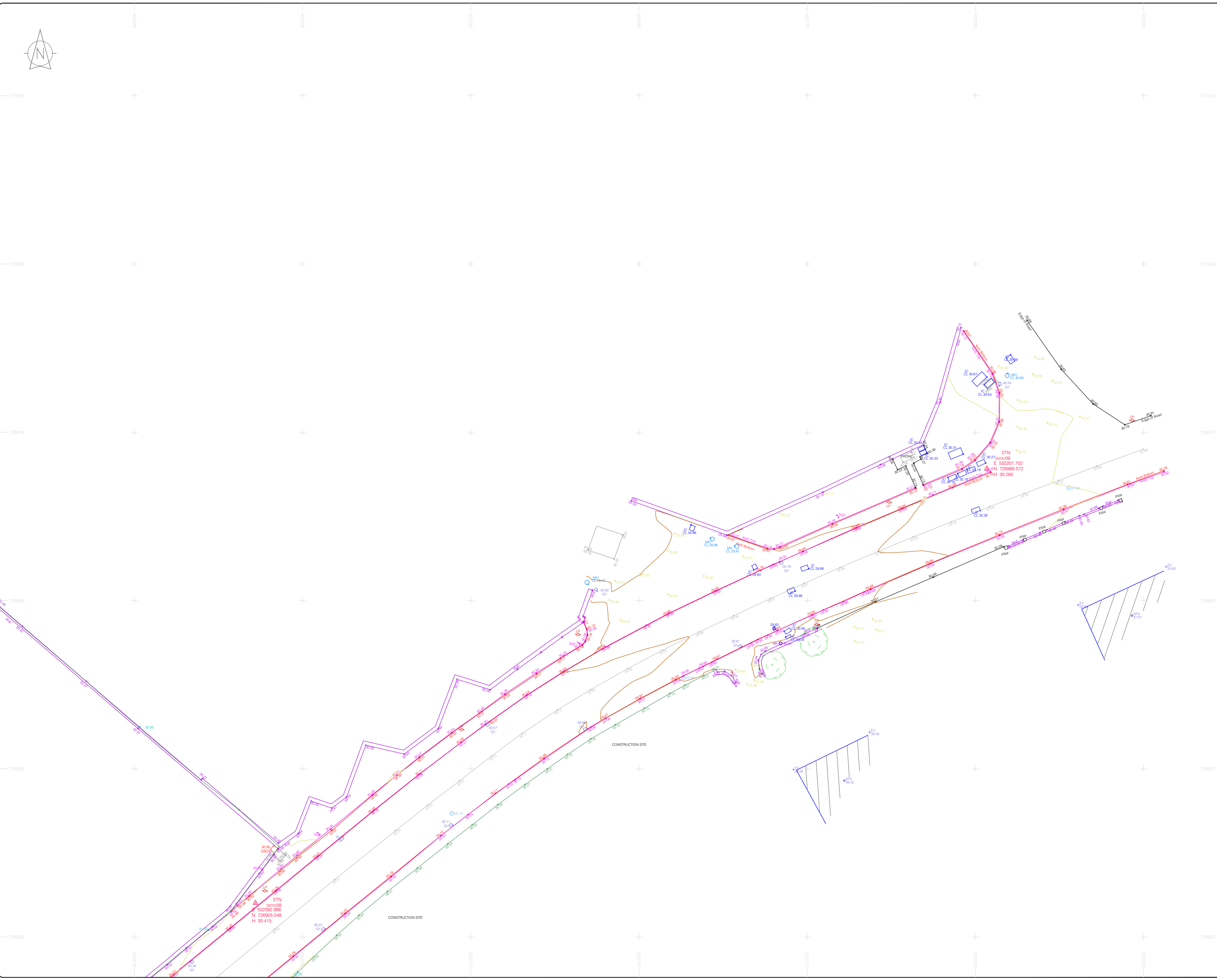
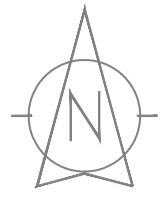

LEGEND
Street furniture & Services

Over Head Wires (LUAS) - Pylon ESB	Street Sign	Phone Box
Flowerbed	Beach Seat	Dust
Pipe	Ballot	Kiosk
Light	Beacon	Gas Cover
Barrier	Coalhole Cover	USG Car Park Vase
Pump	Bore Hole	Waste Bin
Trailer Pit	Electricity Pole	Hydrant
Bus/Tram Shelter	Telegraph pole	Fire Hydrant
Postbox	OCS Pole	ESB Box
Water - General	CCTV Camera Pole	ESB Inspection Cover
Water Valve	Lamp Post	Trains Control Box
Gas Valve	Foul Manhole	LUAS Technical Cabinet
Sluice Valve	Surface Water MH	Ticket Vending Machine
Air Valve	Manholes	Water Meter Cover
Stop Cock	Air Conditioning Vents	Telecom Inspection Cover
C/P Post	Services Inspection Cover	Monument / Toilets
Marker Post	Traffic Inspection Cover	Tank Storage
Traffic Light	Cable TV Inspection Cover	Basement MH, Cover & Pipe
Parking Meter	ESB Inspection Cover	Dispersed Animal Mark
Plane Animal Mark	NL Inspection Cover	Stop for pole
Smart Card Validator	Excise Inspection Cover	Stay for pole
Unknown Valve	Rodding Eye	Pipe Protection
		Washout

Natural Features

Surface Change	Water Level	Golf
Land Drain	Crown Level	Fair Way
Bottom of Slope	Invert level	Green
Top of Slope	Bed Level	Tea Box
Ditch	Spotheight	Other
Water Edge / Lake / Pond		Survey Station
Hedge / Trees Drip Line / Vegetation		Photo point
Tree Coniferous	Tree Deciduous	Top of Tree

Built Features
Roads & Road Markings

Building	Fence	Floor Level
Edge of Road	Gate	Apex Height
Kerb Bottom	Road Centreline	Eaves Height
Kerb Top	Top of Wall	Parapet Height
Bridge Abutment	Hoarding	Soft Elevation
Bridge Deck	Property Line	Step Level
Bridge Pier	Road Bar	Concrete Pad
Building Footpad	Top of Fence	Track
Footpath / Platform Train & Tram	Wall / Retaining Wall	
Damp Proof Course / Veig	Railway / Tram Rail / Gating / Ramp	
Bridge Pier / Wall & Gate Pillar / LUAS Trackbed	Building Canopy / Roof / Overhang	
Cycleway / Private Landing Area		

Murphy Surveys Ltd. Disclaimer

The user or recipient of this survey data understands and acknowledges this data may be inaccurate or contain errors or omissions and the user or recipient assumes full responsibility for any risks or damages resulting from, arising from, or in connection with any use of or reliance upon data displayed herein. Although significant care has been exercised to produce surveys that satisfy survey accuracy standards, these surveys are only as accurate as the source data from which they were compiled. Although all reasonable steps have been taken to locate all features visible at the time of the survey, there is no guarantee that all will be shown on the drawing, as some above ground features may have obstructed the survey. Wherever possible, areas unable to be surveyed will be labelled as "UTS".

The Company shall not be liable for any inaccuracy of the data provided beyond the specified scale or accuracy, or for any matters resulting from their use for purposes other than that stated in the Contract. No liability shall attach to the Surveyor in respect of any consequential loss or damages suffered by the Client.

The Client must promptly notify the Company of any errors in mapping of which it becomes aware. If misleading, inaccurate or otherwise inappropriate information is brought to the Company's attention or the Company itself identifies any such imprecision or error in a survey, it shall use its reasonable endeavours to fix or remove it and if necessary in certain instances, the Company being on notice of any such misleading, inaccurate or otherwise inappropriate information, it will re-conduct the survey and reproduce the data to within the specified scale or accuracy.

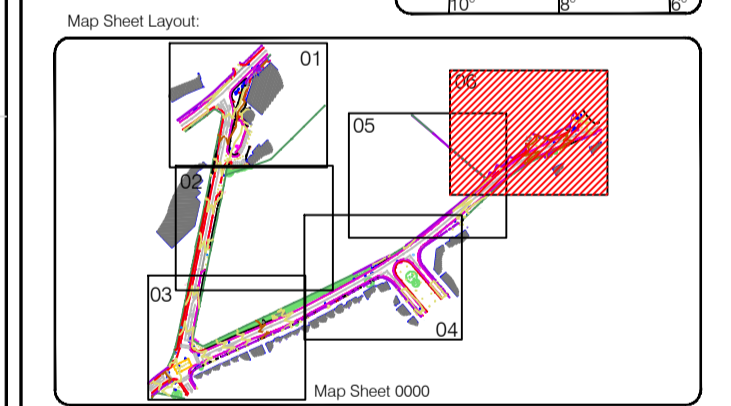
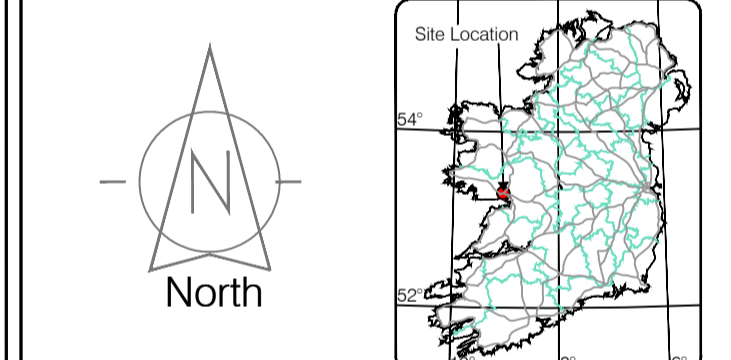
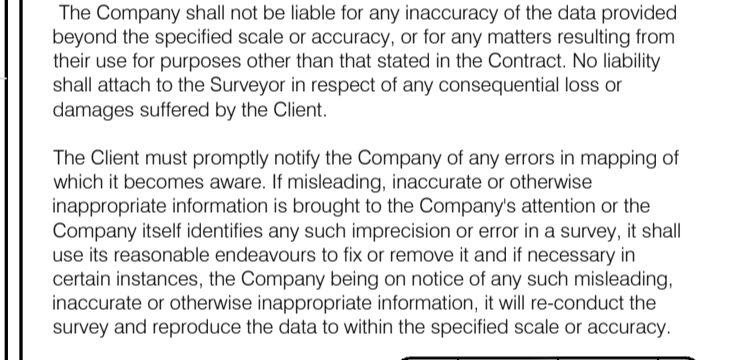

Drawn by: MC	Date: September 2018	Datum: Main Head
Checked by: SF	Date: September 2018	Grid System: Irish National Grid
Checked by: AM	Date: 25.09.2018	Irish National Grid

No	Date	Description
1	25.09.2018	First Drawing

SOCIETY OF CHARTERED SURVEYORS IRELAND

THE SURVEY ASSOCIATION FULL MEMBER

RICS

murphy SURVEYS
GLOBAL CONSULTING SURVEYORS

Topographic surveys, Measured Building Surveys, Setting Out, Air-Photo Surveys, Hydrographic Surveys, Legal Mapping, Pipeline Surveys, Services Location, Ground Penetrating Radar, Laser Scanning, Rectified Photography

Kildare Cork Belfast Glasgow London

Head Office
Global House
Kilcullen Business Campus
Kilcullen Co. Kildare
Ireland

Phone: (+353) 045 484040
Fax: (+353) 045 484004
Email: info@murphysurveys.ie

Client:	Punch Consulting Engineers Limerick
Project:	Crown Square Development
Date:	25.09.2018
Scale:	1:250@A1
Description:	Topographical Survey
Drawing Number:	MSL26811_T_ITM_Rev0_06

© Copyright 2018 MURPHY SURVEYS LTD



Murphy Surveys Ltd. Disclaimer

The survey aims to map all existing utilities and sub surface structures and provide information with respect to pipe size, material type and drainage connectivity. However GPR surveying is limited by the following guidelines and it may not be possible to accurately survey, define and locate all services and sub surface features.

- Locational accuracy is determined by referring to the manufacturers guidelines for the detectors used.
- Existing record information showing underground services is often incomplete and unknown accuracy, therefore it should be regarded only as an indication.
- In ideal conditions these spatial accuracies for the underground utilities are +/- 5% for the R10000 and +/- 10% of depth for the GPR to 2.5m deep. However, variations within the subsurface may alter this estimated accuracy.
- Although all reasonable steps have been taken to locate all features, there is no guarantee that all will be shown on the drawing as some above ground features may have obstructed the survey.
- GPR surveying operates best within high resistivity material. Clay overburden can impair GPR surveying.
- Due to the attenuation of the radar signal with depth, resolution is restricted, hence making identification of anomalies difficult with increasing depth.
- The depth penetration and quality of the data depends on the ground conditions on the site. Poor data may be a result of areas with high conductivity. Also, high reflective materials close to the surface i.e. rebar may hide deeper anomalies.
- It is not always possible to trace the entire length of each underground service.
- It is always our intention to use the Utility providers' details, if supplied prior to survey commencement as a guide for location purposes. However, should we not be able to locate those guided services we shall not be held responsible for the accuracy, or otherwise, of the location of that service, as issued by the utility provider and therefore shown "Taken from Records" on the drawing and we are not liable for any loss that may arise due to the lack of accuracy in the guided information.
- Unless otherwise stated, all services and sub surface structures shown on Murphy Surveys Limited plan drawings have been surveyed using approved detectors and the connections between manholes, if not traced, are assumed to run straight.
- Plan accuracies of the order of +/- 150mm may be achieved but this figure will depend on the depth of the service below ground level. Where similar services run on close proximity, separation may be impossible. Successful tracing of non metallic pipes may be limited.
- Please note that not all buried pipes, cables and ducts can be detected and mapped in consideration of their depth, location, material type, geology and proximity to other utilities. Even an appropriate and professionally executed survey may not be able to achieve a 100% detection rate.
- Services which have been untraceable are shown from Records where possible.
- DP represents distance from the surface level to the top of the service/radar.

No allowance has been made within our quotation, unless otherwise stated, for the location and mapping of unrecorded services. Failure to detect or fully map any declared service will be recorded within the notes accompanying our final drawings.

Where technically possible, depth indications will be given. These should be used for guidance only and wherever critical accuracy is required these should be confirmed by the Client by undertaking that excavations or similar. Bends, lateral service connections, or the close proximity of other services and local magnetic, atmospheric or ground conditions, could in certain situations influence the accuracy of the plan and depth indication facility. Depths will not be provided unless we are reasonably confident of their validity.

Where Murphy Surveys Limited issues a CAD drawn utility service plan, this should be read in conjunction with all available publicly accessible records etc. As part of our exhaustive Quality Control procedures, Murphy Surveys Limited Endeavour to add relevant Public Utility record information into the final issue drawing. An allowance should be made for the width of services, particularly where these are laid in bands or are of significant size etc. For clarification or appropriate easement bands, we would recommend that direct contact is made with the Asset Owner or Statutory Undertaker.

We exclude the following, except where otherwise specified and possible to do so:

- All private service connections, including water or gas fittings where no through flow of applied signal is possible.
- Not extend or disconnected cables or terminated short lengths of pipe.
- Internal building services.
- Fibre optic cables (except where laid with a standard communications cable or built in trace wire or similar conductor system) or can be clearly located using ground penetrating radar.
- Small diameter cables less than 17mm diameter, or pipes less than 38mm diameter.
- Above ground services unless specifically requested.
- Lifting manhole covers which require longer than 10 minute effort using standard heavy duty lifting apparatus.
- Services positioned directly below other pipes or cables etc (i.e. making signals) - intensive verification options available on request.
- Deep non metallic pipes, ducts or culverts (unless probing or Pipe Track 3d is specified as part of the fully inclusive survey contract).
- Passing through defective pipework (displaced joints etc) or acute bends between access points.

Please note that our Quotation does not allow for location of individual service feeds to properties unless reasonable to do so, as access would be required into each property to apply direct connections to inlet points and this would significantly increase the scope of work, survey cost and also cause possible disruption to occupants.

All work carried out by Murphy Surveys Limited (MSL) conforms to the guidelines set out by The Survey Association (TSA).

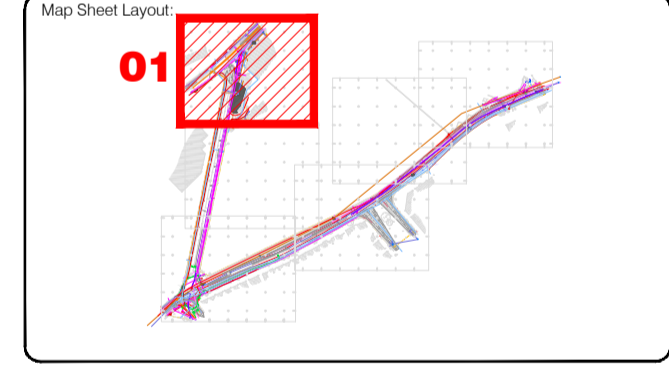
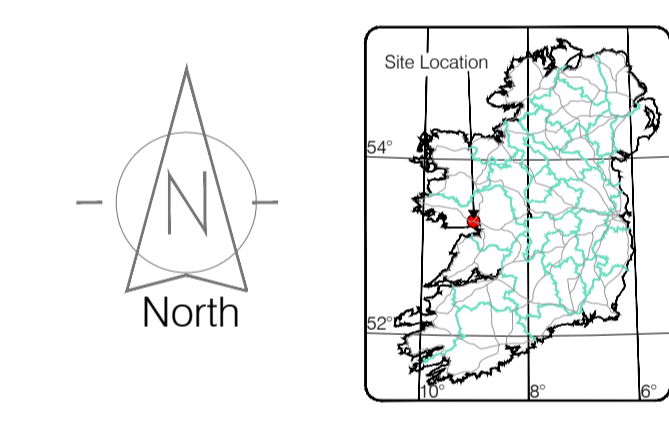

Reviewed by: MSL	Date: September 2018	Drawn by: GP	Date: 16.10.2018	Checked by: DS	Date: 16.10.2018
Date: 16.10.2018		Description: First Drawing		Revisions	
3					

murphy SURVEYS
 GLOBAL CONSULTING UTILITIES
 Topographic surveys, Measured Building Surveys, Setting Out, As-Built Surveys, Hydrographic Surveys, Legal Mapping, Pipeline Surveys, Services Location, Ground Penetrating Radar, Laser Scanning, Revised Photography.

Kildare Cork Belfast Glasgow London

Head Office
 Global House
 Kilsallan Co. Kildare
 Ireland

Phone: (+353) 045 484040
Fax: (+353) 045 484004
Email: info@murphysurveys.ie

Client: Punch Consulting Engineers Limerick

Project: Crown Square Development

Date: 16.10.2018 **Scale:** 1:250@A1

Description: Utility Survey - sheet 1 of 6

Drawing Number: MSL26811-U

© Copyright 2017 MURPHY SURVEYS LTD

The orange line, as shown, on this particular drawing and bounding the entire of the utility survey area is merely for the purpose of indicating the extent of the area that was surveyed. It must not be taken as being commensurate with the extents of the entire of the plot of ground that the Client may own (or not). In order to establish the ownership of the survey area Murphy Surveys do advise consulting with your Client and their legal team.

LEGEND
Underground Utilities

Water Main	Gas
Fire Water	Hydrogen Pipe
Process Water	Oil Pipe
Storm Water Drainage	Magnet
Foul Sewer	Asphalt
Continual Sewer	Traffic
Manhole Chamber	Heating Pipe
Telecom	Electrical
UPC/Origin	Public Lighting
ENET/OCEAN	GPR Anomaly
BT/ESAT	Unknown Cable
Cable	Unknown Duct
Bend / Weld	Nitrogen Pipe
Oxygen Pipe	Undertested Service
Photo point	Weld Point
DP1.0 Depth from ground level to Top of Pipe/GPR Target (m)	Manhole / Inspection Cover
DP1.5 Depth from ground level to Top of Pipe/GPR Target (m)	Unable to Open
Reinforced Concrete (GPR)	Possible Slab (GPR)
Other observations - see description (GPR)	
Survey Station	



The orange line, as shown, on this particular drawing and bounding the entire of the utility survey area is merely for the purpose of indicating the extent of the area that was surveyed. It must not be taken as being commensurate with the extents of the entire of the plot of ground that the Client may own [or not]. In order to establish the ownership of the survey area Murphy Surveys do advise consulting with your Client and their legal team.

LEGEND
Underground Utilities

Water Main	Gas
Fire Water	Hydrogen Pipe
Process Water	Oil Pipe
Storm Water Drainage	Magnet
Foul Sewer	Asphalt
Continual Sewer	Traffic
Manhole Chamber	Heating Pipe
Telecom	Electrical
UPC/Wrigin	Public Lighting
ENET/OCEAN	GPR Anomaly
BT/ESAT	Unknown Cable
Cable	Unknown Duct
Bend / Weld	Nitrogen Pipe
Oxygen Pipe	Undersited Service
Photo point	Weld Point
Depth from ground level to Top of Pipe/GPR Target (m)	Manhole / Inspection Cover Unable to Open
Reinforced Concrete (GPR)	Possible Steel (GPR)
Other observations - see description (GPR)	Survey Station
	Electrical HV (own records)

Murphy Surveys Ltd. Disclaimer

The survey aims to map all existing utilities and sub surface structures and provide information with respect to pipe size, material type and drainage connectivity. However GPR surveying is limited by the following guidelines and it may not be possible to accurately survey, define and locate all services and sub surface features.

- Locational accuracy is determined by referring to the manufacturers guidelines for the detectors used.
- Existing record information showing underground services is often incomplete and unknown accuracy, therefore it should be regarded only as an indication.
- In ideal conditions these spatial accuracies for the underground utilities are +/- 5% for the RD4000 and +/- 10% of depth for the GPR to 2.5m deep. However, variations within the subsurface may alter this estimated accuracy.
- Although all reasonable steps have been taken to locate all features, there is no guarantee that all will be shown on the drawing as some above ground features may have obstructed the survey.
- GPR surveying operates best within high resistivity material. Clay overburden can impair GPR surveying.
- Due to the attenuation of the radar signal with depth, resolution is restricted, hence making identification of anomalies difficult with increasing depth.
- The depth penetration and quality of the data depends on the ground conditions on the site. Poor data may be a result of areas with high conductivity. Also, high reflective materials close to the surface i.e. rebar may hide deeper anomalies.
- It is not always possible to trace the entire length of each underground service.
- It is always our intention to use the Utility providers' details, if supplied prior to survey commencement as a guide for location purposes. However, should we not be able to locate those guided services we shall not be held responsible for the accuracy, or otherwise, of the location of that service, as issued by the utility provider and therefore shown "Taken from Records" on the drawing and we are not liable for any loss that may arise due to the lack of accuracy in the guided information.
- Unless otherwise stated, all services and sub surface structures shown on Murphy Surveys Limited plan drawings have been surveyed using approved detectors and the connections between manholes, if not traced, are assumed to run straight.
- Plan accuracies of the order of +/- 150mm may be achieved but this figure will depend on the depth of the service below ground level. Where similar services run on close proximity, separation may be impossible. Successful tracing of non-metallic pipes may be limited.
- Please note that not all buried pipes, cables and ducts can be detected and mapped in consideration of their depth, location, material type, geology and proximity to other utilities. Even an appropriate and professionally executed survey may not be able to achieve a 100% detection rate.
- Services which have been untraceable are shown from Records where possible.
- DP represents distance from the surface level to the top of the service/radar.

No allowance has been made within our quotation, unless otherwise stated, for the location and mapping of unclassified services. Failure to detect or fully map any declared services will be recorded within the notes accompanying our final drawings.

Where technically possible, depth indications will be given. These should be used for guidance only and wherever critical accuracy is required these should be confirmed by the Client by undertaking that excavations or similar. Bends, lateral service connections, or the close proximity of other services and local magnetic, atmospheric or ground conditions, could in certain situations influence the accuracy of the plan and depth indication facility. Depths will not be provided unless we are reasonably confident of their validity.

Where Murphy Surveys Limited issues a CAD drawn utility service plan, this should be read in conjunction with all available public utility records etc. As part of our exhaustive Quality Control procedures, Murphy Surveys Limited Endeavour to add relevant Public Utility record information onto the final issue drawing. An allowance should be made for the width of services, particularly where these are laid in bands or are of significant size etc. For clarification or appropriate easement bands, we would recommend that direct contact is made with the Asset Owner or Statutory Undertaker.

We exclude the following, except where otherwise specified and possible to do so:

- All private service connections, (including water or gas fittings where no through flow of applied signal is possible).
- Not ended or disconnected cables or terminated short lengths of pipe.
- Internal building services.
- Fibre optic cables (except where laid with a standard communications cable or built in trace wire or similar conductor system) or can be clearly located using ground penetrating radar.
- Small diameter cables less than 17mm diameter, or pipes less than 38mm diameter.
- Above ground services unless specifically requested.
- Lifting manhole covers which require longer than 10 minute effort using standard heavy duty lifting apparatus.
- Services positioned directly below other pipes or cables etc (i.e. masking signal) - intrusive verification options available on request.
- Deep non metallic pipes, ducts or culverts (unless probing or Pipe Track 3d is specified as part of the fully invasive survey option).
- Passing through defective pipework (displaced joints etc) or acute bends between access points.

Please note that our Quotation does not allow for location of individual service feeds to properties unless reasonable to do so, as access would be required into each property to apply direct connections to inlet points and this would significantly increase the scope of work, survey cost and also cause possible disruption to occupants.

All work carried out by Murphy Surveys Limited (MSL) conforms to the guidelines set out by The Survey Association (TSA).

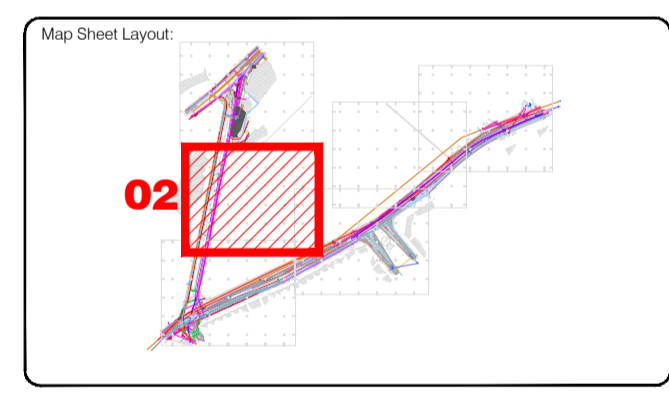
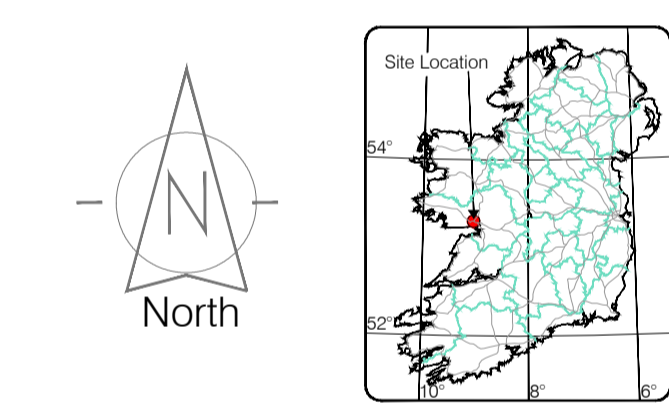

Drawn by: MSL	Date: September 2018	Datum: Mean Head
Drawn by: EP	Date: 16.10.2018	Grid System: Irish National Grid
Checked by: DS	Date: 16.10.2018	Irish National Grid

No	Date	Revisions
3	16.10.2018	First Drawing



murphy
SURVEYS
GLOBAL CONSULTING ENGINEERS

Kildare Cork Belfast Glasgow London

Head Office
Global House
Kilcullen Business Campus
Kilcullen Co. Kildare
Ireland

Phone: (+353) 045 484040
Fax: (+353) 045 484004
Email: info@murphysurveys.ie

Client: Punch Consulting Engineers Limerick

Project: Crown Square Development

Date: 16.10.2018 **Scale:** 1:250@A1

Description: Utility Survey - sheet 2 of 6

Drawing Number: MSL26811-U

© Copyright 2017 MURPHY SURVEYS LTD

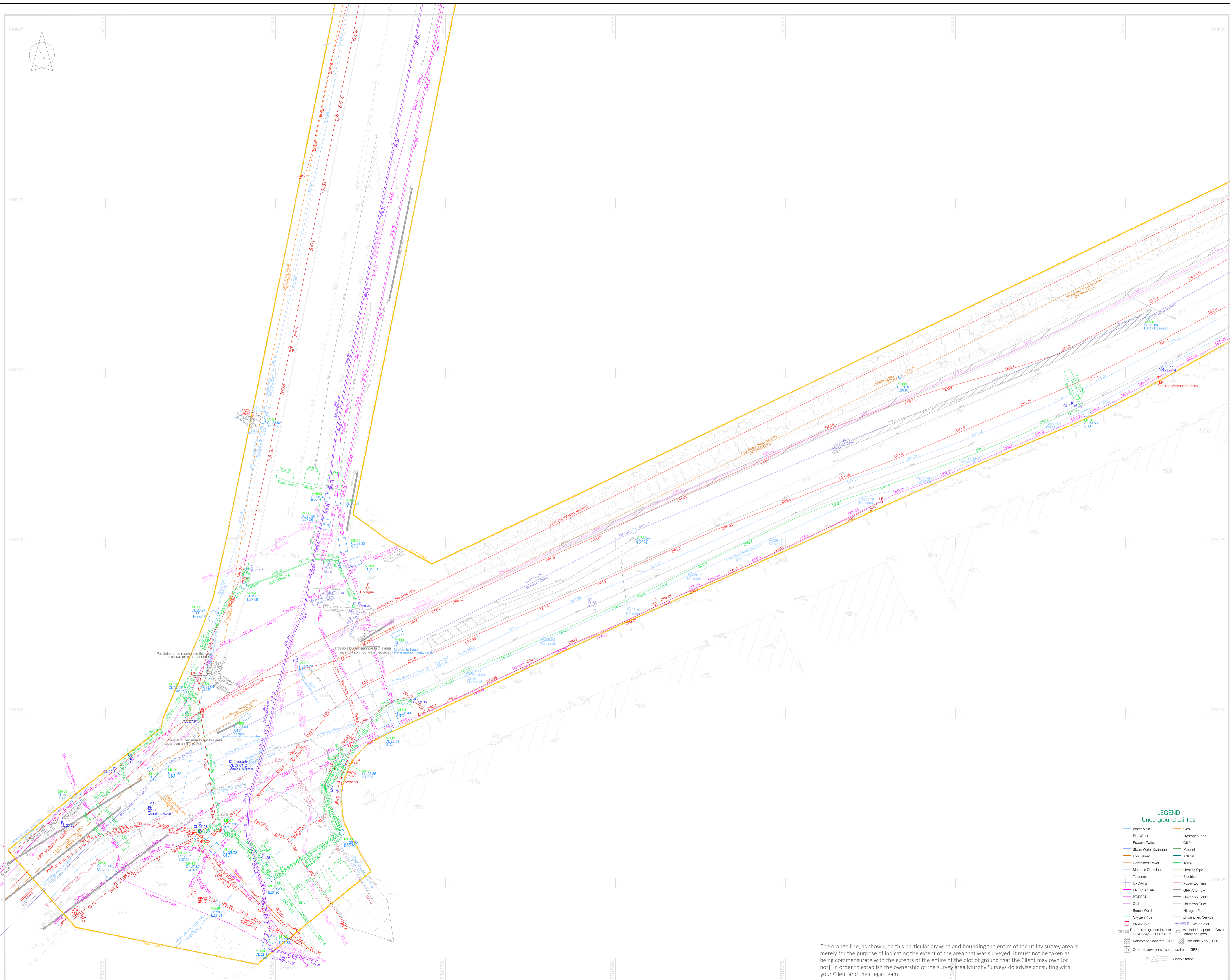

The orange line, as shown, on this particular drawing and bounding the entire of the utility survey area is merely for the purpose of indicating the extent of the area that was surveyed. It must not be taken as being commensurate with the extents of the entire of the plot of ground that the Client may own (or not). In order to establish the ownership of the survey area Murphy Surveys do advise consulting with your Client and their legal team.

Murphy Surveys Ltd. Disclaimer

The survey aims to map all existing utilities and sub surface structures and provide information with respect to pipe size, material type and drainage connectivity. However GPR surveying is limited by the following guidelines and it may not be possible to accurately survey, define and locate all services and sub surface features.

- Locational accuracy is determined by referring to the manufacturers guidelines for the detectors used.
- Existing record information showing underground services is often incomplete and unknown accuracy, therefore it should be regarded only as an indication.
- In ideal conditions these spatial accuracies for the underground utilities are +/- 5% for the RD4000 and +/- 10% of depth for the GPR to 2.5m deep. However, variations within the subsurface may alter this estimated accuracy.
- Although all reasonable steps have been taken to locate all features, there is no guarantee that all will be shown on the drawing as some above ground features may have obstructed the survey.
- GPR surveying operates best within high resistivity material. Clay overburden can impair GPR surveying.
- Due to the attenuation of the radar signal with depth, resolution is restricted, hence making identification of anomalies difficult with increasing depth.
- The depth penetration and quality of the data depends on the ground conditions on the site. Poor data may be a result of areas with high conductivity. Also, high reflective materials close to the surface i.e. rebar may hide deeper anomalies.
- It is not always possible to trace the entire length of each underground service.
- It is always our intention to use the Utility providers' details, if supplied prior to survey commencement as a guide for location purposes. However, should we not be able to locate those guided services we shall not be held responsible for the accuracy, or otherwise, of the location of that service, as issued by the utility provider and therefore shown "Taken from Records" on the drawing and we are not liable for any loss that may arise due to the lack of accuracy in the guided information.
- Unless otherwise stated, all services and sub surface structures shown on Murphy Surveys Limited plan drawings have been surveyed using approved detectors and the connections between manholes, if not traced, are assumed to run straight.
- Plan accuracies of the order of +/- 150mm may be achieved but this figure will depend on the depth of the service below ground level. Where similar services run on close proximity, separation may be impossible. Successful tracing of non metallic pipes may be limited.
- Please note that not all buried pipes, cables and ducts can be detected and mapped in consideration of their depth, location, material type, geology and proximity to other utilities. Even an appropriate and professionally executed survey may not be able to achieve a 100% detection rate.
- Services which have been untraceable are shown from Records where possible.
- DP represents distance from the surface level to the top of the service/radar.

No allowance has been made within our quotation, unless otherwise stated, for the location and mapping of unrecorded services. Failure to detect or fully map any declared service will be recorded within the notes accompanying our final drawings.

Where technically possible, depth indications will be given. These should be used for guidance only and wherever critical accuracy is required these should be confirmed by the Client by undertaking that excavations or similar. Bends, lateral service connections, or the close proximity of other services and local magnetic, atmospheric or ground conditions, could in certain situations influence the accuracy of the plan and depth indication facility. Depths will not be provided unless we are reasonably confident of their validity.

Where Murphy Surveys Limited issues a CAD drawn utility service plan, this should be read in conjunction with all available publicly utility records etc. As part of our exhaustive Quality Control procedures, Murphy Surveys Limited Endeavour to add relevant Public Utility record information onto the final issue drawing. An allowance should be made for the width of services, particularly where these are laid in bands or are of significant size etc. For clarification or appropriate easement bands, we would recommend that direct contact is made with the Asset Owner or Statutory Undertaker.

We exclude the following, except where otherwise specified and possible to do so:

- All private service connections, (including water or gas fittings where no through flow of applied signal is possible).
- Not ended or disconnected cables or terminated short lengths of pipe.
- Internal building services.
- Fibre optic cables (except where laid with a standard communications cable or built in tracer wire or similar conductor system) or can be clearly located using ground penetrating radar.
- Small diameter cables less than 17mm diameter, or pipes less than 38mm diameter.
- Above ground services unless specifically requested.
- Lifting manhole covers which require longer than 10 minute effort using standard heavy duty lifting apparatus.
- Services positioned directly below other pipes or cables etc (i.e. masking signal) - Invasive verification options available on request.
- Deep non metallic pipes, ducts or culverts (unless probing or Pipe Track 3d is specified as part of the fully invasive survey option).
- Passing through defective pipework (displaced joints etc) or acute bends between access points.

Please note that our Quotation does not allow for location of individual service feeds to properties unless reasonable to do so, as access would be required into each property to apply direct connections to inlet points and this would significantly increase the scope of work, survey cost and also cause possible disruption to occupants.

All work carried out by Murphy Surveys Limited (MSL) conforms to the guidelines set out by The Survey Association (TSA).

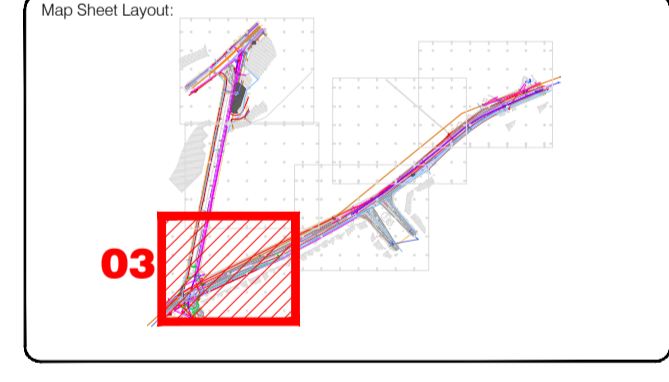
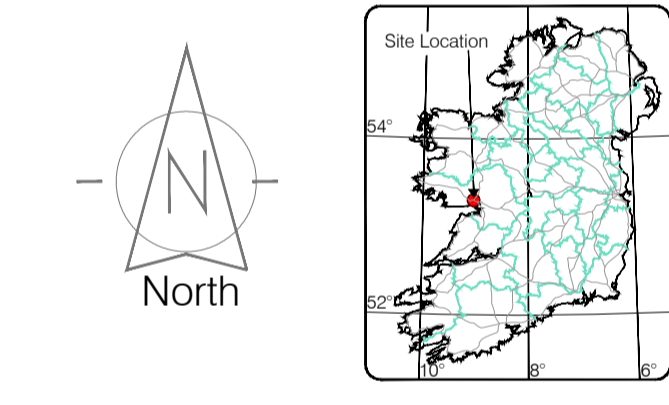

Drawn by: EP	Date: 16.10.2018	Grid System: Irish National Grid (ITM)
Checked by: DS	Date: 16.10.2018	

No.	Date	Description	Revisions
3	16.10.2018	First Drawing	

murphy SURVEYS
GLOBAL CONSULTING SURVEYORS

Topographic surveys, Measured Building Surveys, Setting Out, As-Built Surveys, Hydrographic Surveys, Legal Mapping, Pipeline Surveys, Services Location, Ground Penetrating Radar, Laser Scanning, Aerial Photography

Kildare Cork Belfast Glasgow London

Head Office
Global House
Kilcullen Business Campus
Kilcullen Co. Kildare
Ireland

Phone: (+353) 045 484040
Fax: (+353) 045 484004
Email: info@murphysurveys.ie

Client: Punch Consulting Engineers Limerick

Project: Crown Square Development

Date: 16.10.2018 **Scale:** 1:250@A1

Description: Utility Survey - sheet 3 of 6

Drawing Number: MSL26811-U

© Copyright 2017 MURPHY SURVEYS LTD

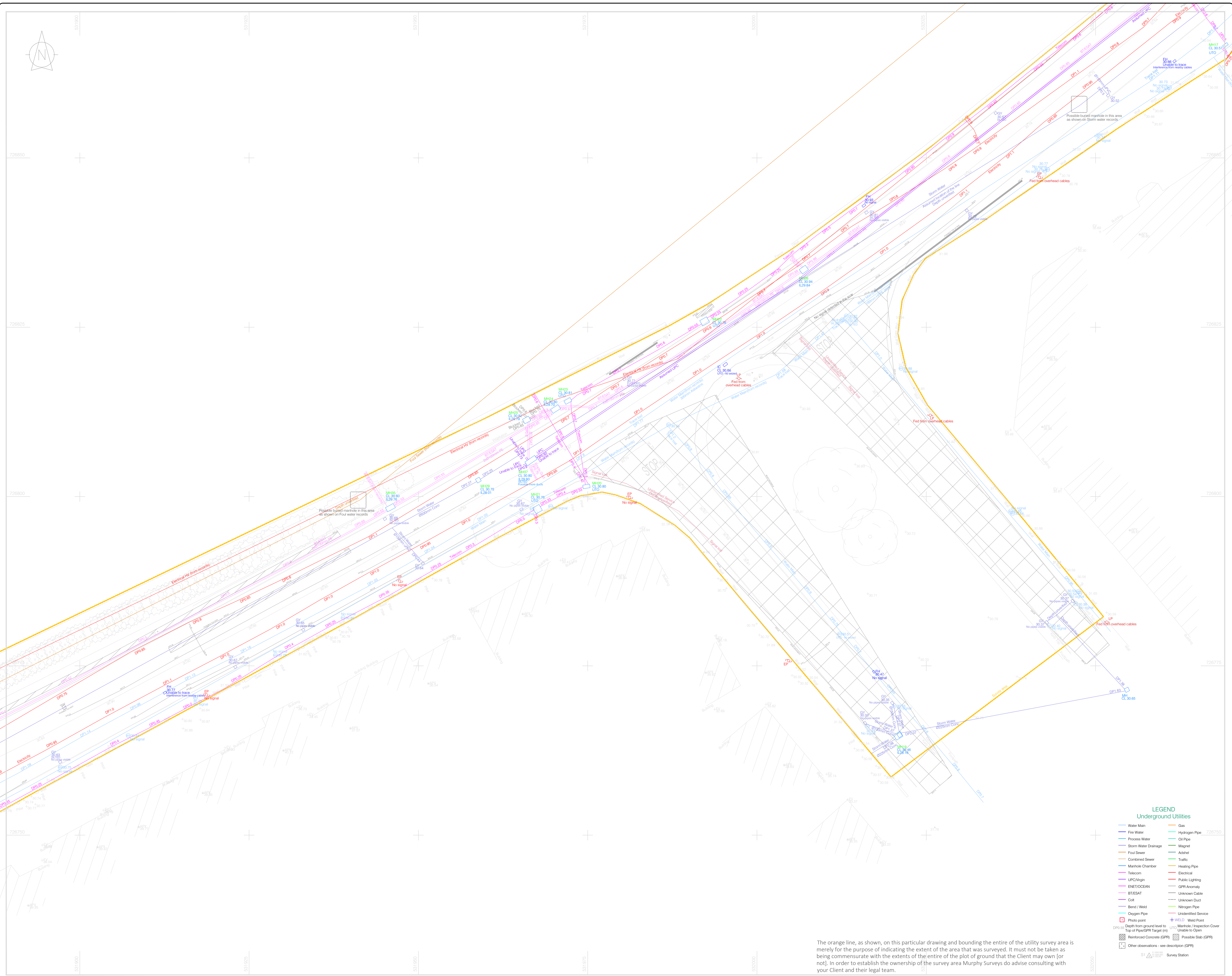

Murphy Surveys Ltd. Disclaimer

The survey aims to map all existing utilities and sub surface structures and provide information with respect to pipe size, material type and drainage connectivity. However GPR surveying is limited by the following guidelines and it may not be possible to accurately survey, define and locate all services and sub surface features.

- Locational accuracy is determined by referring to the manufacturers guidelines for the detectors used.
- Existing record information showing underground services is often incomplete and unknown accuracy, therefore it should be regarded only as an indication.
- In ideal conditions these spatial accuracies for the underground utilities are +/- 5% for the R10400 and +/- 10% of depth for the GPR to 2.5m deep. However, variations within the subsurface may alter this estimated accuracy.
- Although all reasonable steps have been taken to locate all features, there is no guarantee that all will be shown on the drawing as some above ground features may have obstructed the survey.
- GPR surveying operates best within high resistivity material. Clay overburden can impair GPR surveying.
- Due to the attenuation of the radar signal with depth, resolution is restricted, hence making identification of anomalies difficult with increasing depth.
- The depth penetration and quality of the data depends on the ground conditions on the site. Poor data may be a result of areas with high conductivity. Also, high reflective materials close to the surface i.e. rebar may hide deeper anomalies.
- It is not always possible to trace the entire length of each underground service.
- It is always our intention to use the Utility providers' details, if supplied prior to survey commencement as a guide for location purposes. However, should we not be able to locate those guided services we shall not be held responsible for the accuracy, or otherwise, of the location of that service, as issued by the utility provider and therefore shown "Taken from Records" on the drawing and we are not liable for any loss that may arise due to the lack of accuracy in the guided information.
- Unless otherwise stated, all services and sub surface structures shown on Murphy Surveys Limited plan drawings have been surveyed using approved detectors and the connections between manholes, if not traced, are assumed to run straight.
- Plan accuracies of the order of +/- 150mm may be achieved but this figure will depend on the depth of the service below ground level. Where similar services run on close proximity, separation may be impossible. Successful tracing of non metallic pipes may be limited.
- Please note that not all buried pipes, cables and ducts can be detected and mapped in consideration of their depth, location, material type, geology and proximity to other utilities. Even an appropriate and professionally executed survey may not be able to achieve a 100% detection rate.
- Services which have been untraceable are shown from Records where possible.
- DP represents distance from the surface level to the top of the service/radar.

No allowance has been made within our quotation, unless otherwise stated, for the location and mapping of underground services. Failure to detect or fully map any declared service will be recorded within the notes accompanying our final drawings.

Where technically possible, depth indications will be given. These should be used for guidance only and wherever critical accuracy is required these should be confirmed by the Client by undertaking that excavations or similar. Bends, lateral service connections, or the close proximity of other services and local magnetic, atmospheric or ground conditions, could in certain situations influence the accuracy of the plan and depth indication facility. Depths will not be provided unless we are reasonably confident of their validity.

Where Murphy Surveys Limited issues a CAD drawn utility service plan, this should be read in conjunction with all available publicly utility records etc. As part of our exhaustive Quality Control procedures, Murphy Surveys Limited Endeavour to add relevant Public Utility record information onto the final issue drawing. An allowance should be made for the width of services, particularly where these are laid in bands or are of significant size etc. For clarification or appropriate easement bands, we would recommend that direct contact is made with the Asset Owner or Statutory Undertaker.

We exclude the following, except where otherwise specified and possible to do so:

- All private service connections, including water or gas fittings where no through flow of applied signal is possible.
- Flat ended or disconnected cables or terminated short lengths of pipe.
- Internal building services.
- Fibre optic cables (except where laid with a standard communications cable or built in tracer wire or similar conductor system) or can be clearly located using ground penetrating radar.
- Small diameter cables less than 17mm diameter, or pipes less than 38mm diameter.
- Above ground services unless specifically requested.
- Lifting manhole covers which require longer than 10 minute effort using standard heavy duty lifting apparatus.
- Services positioned directly below other pipes or cables etc. (i.e. masking signal) - intrusive verification options available on request.
- Deep non metallic pipes, ducts or culverts (unless probing or Pipe Track 3d is specified as part of the fully inclusive survey option).
- Passing through defective pipework (displaced joints etc) or acute bends between access points.

Please note that our Quotation does not allow for location of individual service feeds to properties unless reasonable to do so, as access would be required into each property to apply direct connections to inlet points and this would significantly increase the scope of work, survey cost and also cause possible disruption to occupants.

All work carried out by Murphy Surveys Limited (MSL) conforms to the guidelines set out by The Survey Association (TSA).

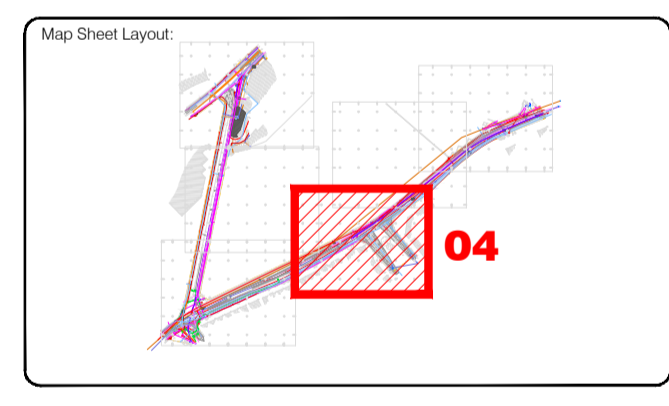
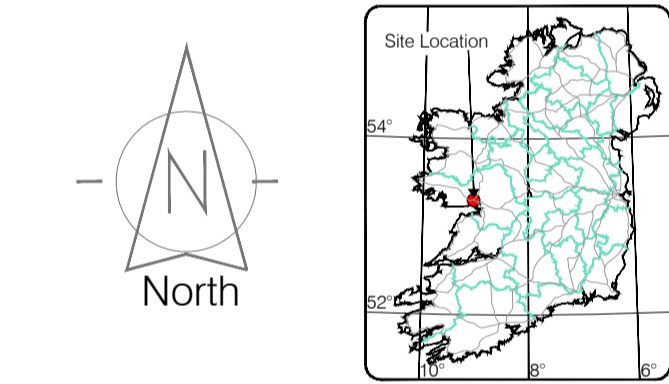

Drawn by: MSL	Date: September 2018	Drawn: Main Head
Checked by: DS	Date: 16.10.2018	Grid System: Irish National Grid (ITM)
Checked by: DS		
Date: 16.10.2018		
Description: First Drawing		

murphy SURVEYS

 GLOBAL CONSULTING SURVEYS

Topographic surveys, Measured Building Surveys, Setting Out, As-Built Surveys, Hydrographic Surveys, Legal Mapping, Pipeline Surveys, Services Location, Ground Penetrating Radar, Laser Scanning, Rectified Photography

Kildare Cork Belfast Glasgow London

Head Office
 Global House
 Kildare Business Campus
 Kildare Co. Kildare
 Ireland

Phone: (+353) 045 484040
 Fax: (+353) 045 484004
 Email: info@murphysurveys.ie

Client: Punch Consulting Engineers Limerick

Project: Crown Square Development

Date: 16.10.2018 **Scale:** 1:250@A1

Description: Utility Survey - sheet 4 of 6

Drawing Number: MSL26811-U

© Copyright 2017 MURPHY SURVEYS LTD

The orange line, as shown, on this particular drawing and bounding the entire of the utility survey area is merely for the purpose of indicating the extent of the area that was surveyed. It must not be taken as being commensurate with the extents of the entire of the plot of ground that the Client may own (or not). In order to establish the ownership of the survey area Murphy Surveys do advise consulting with your Client and their legal team.

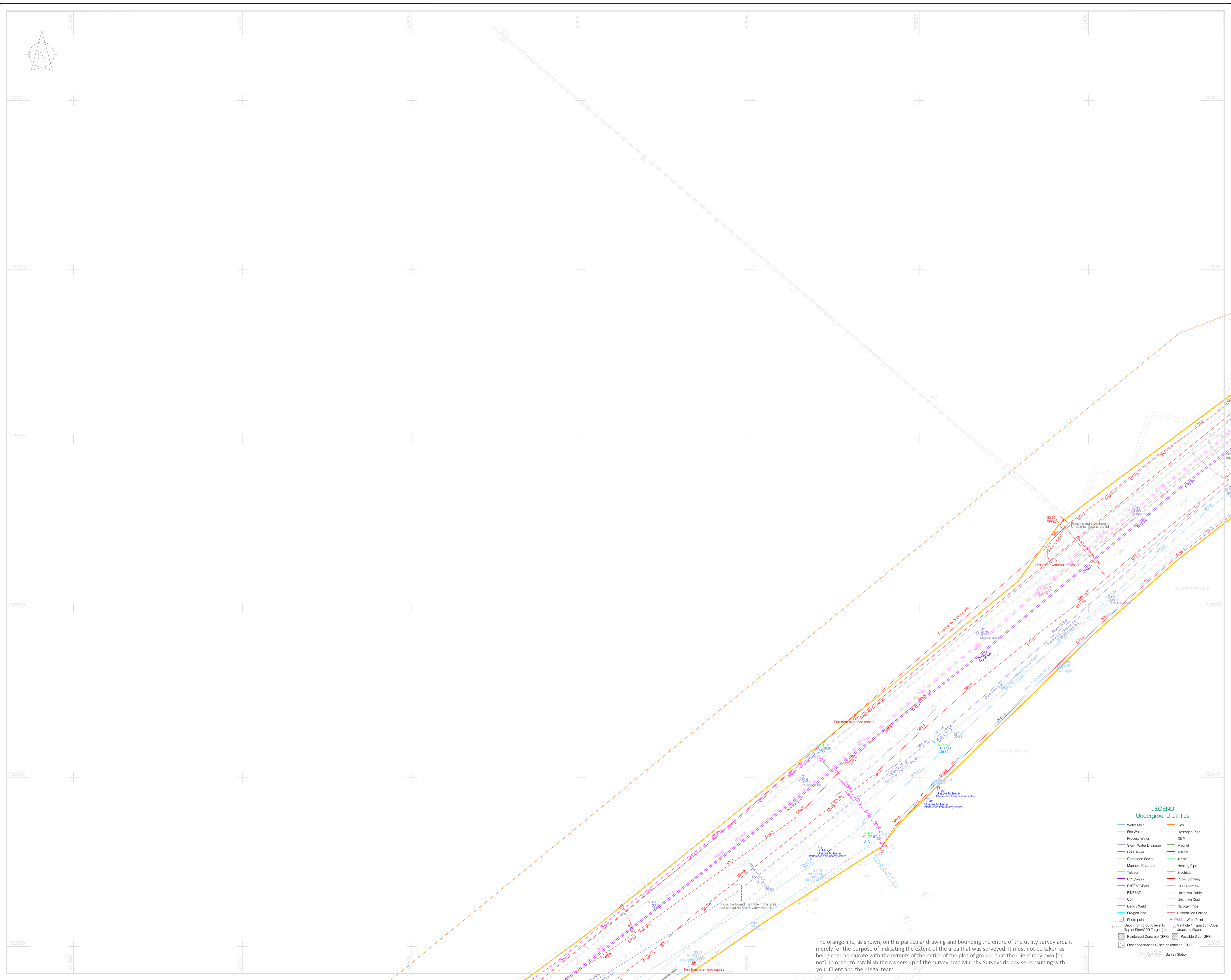

The orange line, as shown, on this particular drawing and bounding the entire of the utility survey area is merely for the purpose of indicating the extent of the area that was surveyed. It must not be taken as being commensurate with the extents of the entire of the plot of ground that the Client may own [or not]. In order to establish the ownership of the survey area Murphy Surveys do advise consulting with your Client and their legal team.

Murphy Surveys Ltd. Disclaimer

The survey aims to map all existing utilities and sub surface structures and provide information with respect to pipe size, material type and drainage connectivity. However GPR surveying is limited by the following guidelines and it may not be possible to accurately survey, define and locate all services and sub surface features.

- Locational accuracy is determined by referring to the manufacturers guidelines for the detectors used.
- Existing record information showing underground services is often incomplete and unknown accuracy, therefore it should be regarded only as an indication.
- In ideal conditions these spatial accuracies for the underground utilities are +/ - 5% for the R10000 and +/ - 10% at depth for the GPR to 2.5m deep. However, variations within the subsurface may alter this estimated accuracy.
- Although all reasonable steps have been taken to locate all features, there is no guarantee that all will be shown on the drawing as some above ground features may have obstructed the survey.
- GPR surveying operates best within high resistivity material. Clay overburden can impair GPR surveying.
- Due to the attenuation of the radar signal with depth, resolution is restricted, hence making identification of anomalies difficult with increasing depth.
- The depth penetration and quality of the data depends on the ground conditions on the site. Poor data may be a result of areas with high conductivity. Also, high reflective materials close to the surface i.e. rebar may hide deeper anomalies.
- It is not always possible to trace the entire length of each underground service.
- It is always our intention to use the Utility providers' details, if supplied prior to survey commencement as a guide for location purposes. However, should we not be able to locate those guided services we shall not be held responsible for the accuracy, or otherwise, of the location of that service, as issued by the utility provider and therefore shown "Taken from Records" on the drawing and we are not liable for any loss that may arise due to the lack of accuracy in the guided information.
- Unless otherwise stated, all services and sub surface structures shown on Murphy Surveys Limited plan drawings have been surveyed using approved detectors and the connections between manholes, if not traced, are assumed to run straight.
- Plan accuracies of the order of + or - 150mm may be achieved but this figure will depend on the depth of the service below ground level. Where similar services run on close proximity, separation may be impossible. Successful tracing of non metallic pipes may be limited.
- Please note that not all buried pipes, cables and ducts can be detected and mapped in consideration of their depth, location, material type, geology and proximity to other utilities. Even an appropriate and professionally recorded survey may not be able to achieve a 100% detection rate.
- Services which have been untraceable are shown from Records where possible.
- DP represents distance from the surface level to the top of the service/radar.

No allowance has been made within our quotation, unless otherwise stated, for the location and mapping of undeclared services. Failure to detect or fully map any declared services will be recorded within the notes accompanying our final drawings.

Where technically possible, depth indications will be given. These should be used for guidance only and wherever critical accuracy is required these should be confirmed by the Client by undertaking that excavations or similar. Bends, lateral service connections, or the close proximity of other services and local magnetic, atmospheric or ground conditions, could in certain situations influence the accuracy of the plan and depth indication facility. Depths will not be provided unless we are reasonably confident of their validity.

Where Murphy Surveys Limited issues a CAD drawn utility service plan, this should be read in conjunction with all available publicly utility records etc. As part of our exhaustive Quality Control procedures, Murphy Surveys Limited Endeavour to add relevant Public Utility record information onto the final issue drawing. An allowance should be made for the width of services, particularly where these are laid in bands or are of significant size etc. For clarification or appropriate easement bands, we would recommend that direct contact is made with the Asset Owner or Statutory Undertaker.

We exclude the following, except where otherwise specified and possible to do so:

- All private service connections, including water or gas fittings where no through flow of applied signal is possible.
- Flat ended or disconnected cables or terminated short lengths of pipe.
- Internal building services.
- Fibre optic cables (except where laid with a standard communications cable or built in trace wire or similar conductor system) or can be clearly located using ground penetrating radar.
- Small diameter cables less than 17mm diameter, or pipes less than 38mm diameter.
- Above ground services unless specifically requested.
- Lifting manhole covers which require longer than 10 minute effort using standard heavy duty lifting apparatus.
- Services positioned directly below other pipes or cables etc (i.e. masking signal) - intensive verification options available on request.
- Deep non metallic pipes, ducts or culverts (unless probing or Pipe Track 3d is specified as part of the fully inclusive survey option).
- Passing through defective pipework (displaced joints etc) or acute bends between access points.

Please note that our Quotation does not allow for location of individual service feeds to properties unless reasonable to do so, as access would be required into each property to apply direct connections to inlet points and this would significantly increase the scope of work, survey cost and also cause possible disruption to occupants.

All work carried out by Murphy Surveys Limited (MSL) conforms to the guidelines set out by The Survey Association (TSA).

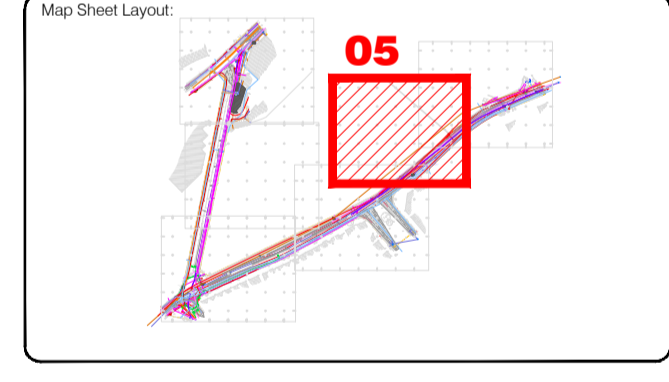
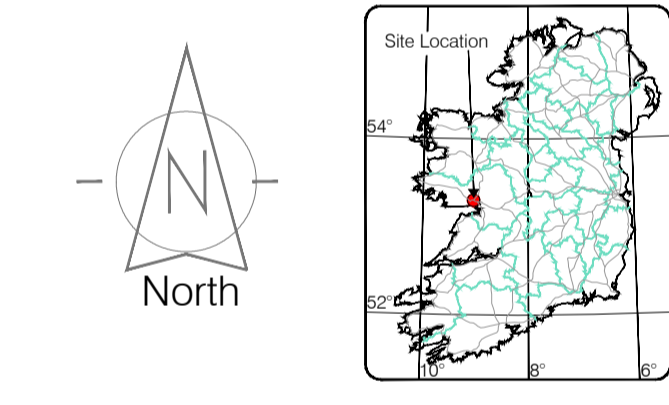

Drawn by: MSL	Date: September 2018	Drawn: Main Head
Checked by: EP	Date: 16.10.2018	Grid System: Irish National Grid (ITM)
Checked by: DS	Date: 16.10.2018	Grid System: Irish National Grid (ITM)

No.	Date	Revisions
3	16.10.2018	First Drawing

murphy SURVEYS
GLOBAL CONSULTING SURVEYORS

Topographic surveys, Measured Building Surveys, Setting Out, As-Built Surveys, Hydrographic Surveys, Legal Mapping, Pipeline Surveys, Services Location, Ground Penetrating Radar, Laser Scanning, Revised Photogrammetry

Kildare Cork Belfast Glasgow London

Head Office
Global House
Kilcullen Business Campus
Kilcullen Co. Kildare
Ireland

Phone: (+353) 045 484040
Fax: (+353) 045 484004
Email: info@murphysurveys.ie

Client: Punch Consulting Engineers Limerick

Project: Crown Square Development

Date: 16.10.2018 **Scale:** 1:250@A1

Description: Utility Survey - sheet 5 of 6

Drawing Number: MSL26811-U

© Copyright 2017 MURPHY SURVEYS LTD

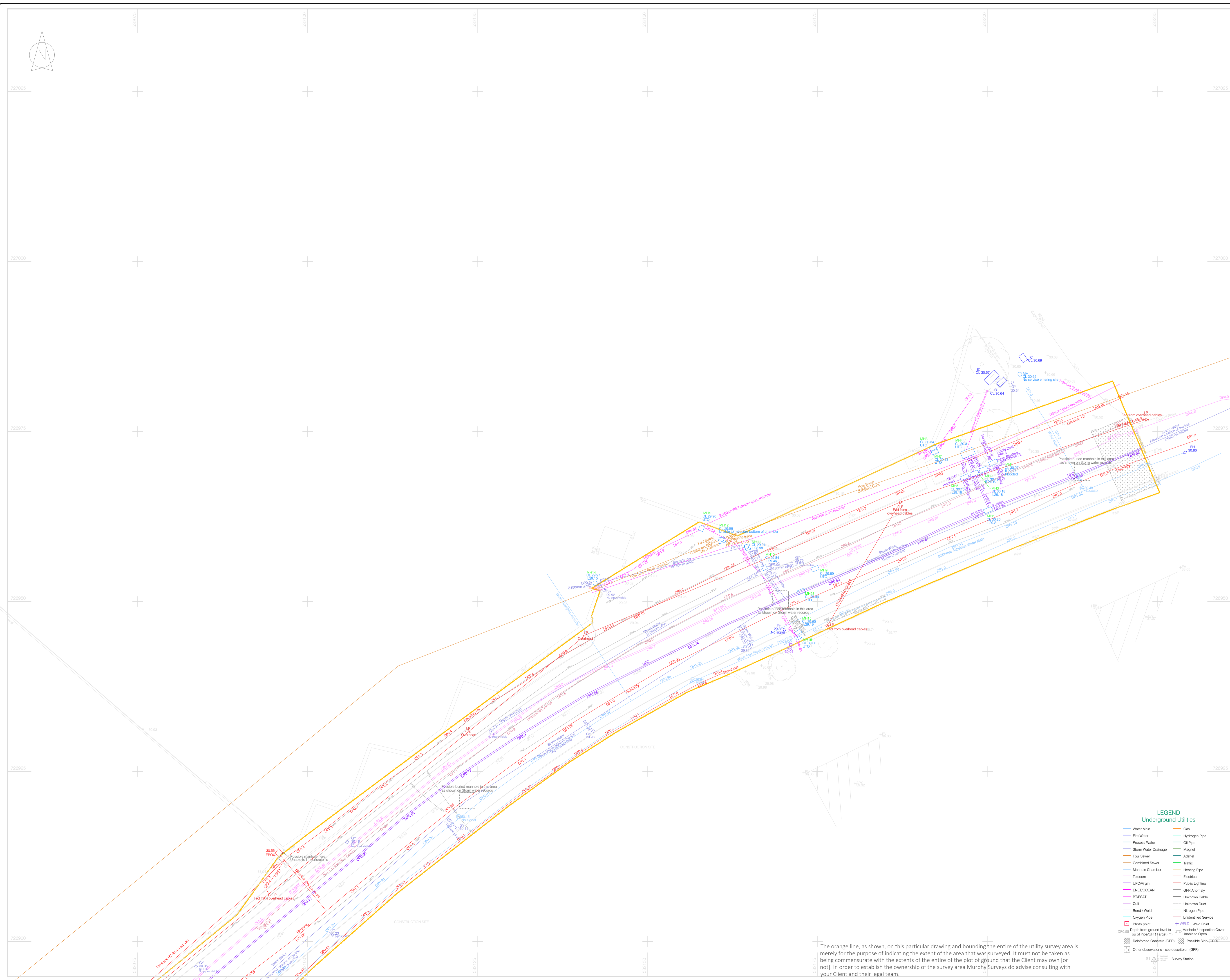

Murphy Surveys Ltd. Disclaimer

The survey aims to map all existing utilities and sub surface structures and provide information with respect to pipe size, material type and drainage connectivity. However GPR surveying is limited by the following guidelines and it may not be possible to accurately survey, define and locate all services and sub surface features.

- Locational accuracy is determined by referring to the manufacturers guidelines for the detectors used.
- Existing record information showing underground services is often incomplete and unknown accuracy, therefore it should be regarded only as an indication.
- In ideal conditions these spatial accuracies for the underground utilities are +/- 5% for the R10400 and +/- 10% of depth for the GPR to 2.5m deep. However, variations within the subsurface may alter this estimated accuracy.
- Although all reasonable steps have been taken to locate all features, there is no guarantee that all will be shown on the drawing as some above ground features may have obstructed the survey.
- GPR surveying operates best within high resistivity material. Clay overburden can impair GPR surveying.
- Due to the attenuation of the radar signal with depth, resolution is restricted, hence making identification of anomalies difficult with increasing depth.
- The depth penetration and quality of the data depends on the ground conditions on the site. Poor data may be a result of areas with high conductivity. Also, high reflective materials close to the surface i.e. rebar may hide deeper anomalies.
- It is not always possible to trace the entire length of each underground service.
- It is always our intention to use the Utility providers' details, if supplied prior to survey commencement as a guide for location purposes. However, should we not be able to locate those guided services we shall not be held responsible for the accuracy, or otherwise, of the location of that service, as issued by the utility provider and therefore shown "Taken from Records" on the drawing and we are not liable for any loss that may arise due to the lack of accuracy in the guided information.
- Unless otherwise stated, all services and sub surface structures shown on Murphy Surveys Limited plan drawings have been surveyed using approved detectors and the connections between manholes, if not traced, are assumed to run straight.
- Plan accuracies of the order of +/- 150mm may be achieved but this figure will depend on the depth of the service below ground level. Where similar services run on close proximity, separation may be impossible. Successful tracing of non metallic pipes may be limited.
- Please note that not all buried pipes, cables and ducts can be detected and mapped in consideration of their depth, location, material type, geology and proximity to other utilities. Even an appropriate and professionally recorded survey may not be able to achieve a 100% detection rate.
- Services which have been untraceable are shown from Records where possible.
- DP represents distance from the surface level to the top of the service/radar.

No allowance has been made within our quotation, unless otherwise stated, for the location and mapping of unrecorded services. Failure to detect or fully map any declared service will be recorded within the notes accompanying our final drawings.

Where technically possible, depth indications will be given. These should be used for guidance only and wherever critical accuracy is required these should be confirmed by the Client by undertaking that excavations or similar. Bends, lateral service connections, or the close proximity of other services and local magnetic, atmospheric or ground conditions, could in certain situations influence the accuracy of the plan and depth indication facility. Depths will not be provided unless we are reasonably confident of their validity.

Where Murphy Surveys Limited issues a CAD drawn utility service plan, this should be read in conjunction with all available publicly utility records etc. As part of our exhaustive Quality Control procedures, Murphy Surveys Limited Endeavour to add relevant Public Utility record information onto the final issue drawing. An allowance should be made for the width of services, particularly where these are laid in bands or are of significant size etc. For clarification or appropriate easement bands, we would recommend that direct contact is made with the Asset Owner or Statutory Undertaker.

We exclude the following, except where otherwise specified and possible to do so:

- All private service connections, (including water or gas fittings where no through flow of applied signal is possible).
- Not extend or disconnected cables or terminated short lengths of pipe.
- Internal building services.
- Fibre optic cables (except where laid with a standard communications cable or built in tracer wire or similar conductor system) or can be clearly located using ground penetrating radar.
- Small diameter cables less than 17mm diameter, or pipes less than 38mm diameter.
- Above ground services unless specifically requested.
- Lifting manhole covers which require longer than 10 minute effort using standard heavy duty lifting apparatus.
- Services positioned directly below other pipes or cables etc. (i.e. making signal) - intrusive verification options available on request.
- Deep non metallic pipes, ducts or culverts (unless probing or Pipe Track 3d is specified as part of the fully invasive survey option).
- Passing through defective pipework (displaced joints etc) or acute bends between access points.

Please note that our Quotation does not allow for location of individual service feeds to properties unless reasonable to do so, as access would be required into each property to apply direct connections to inlet points and this would significantly increase the scope of work, survey cost and also cause possible disruption to occupants.

All work carried out by Murphy Surveys Limited (MSL) conforms to the guidelines set out by The Survey Association (TSA).

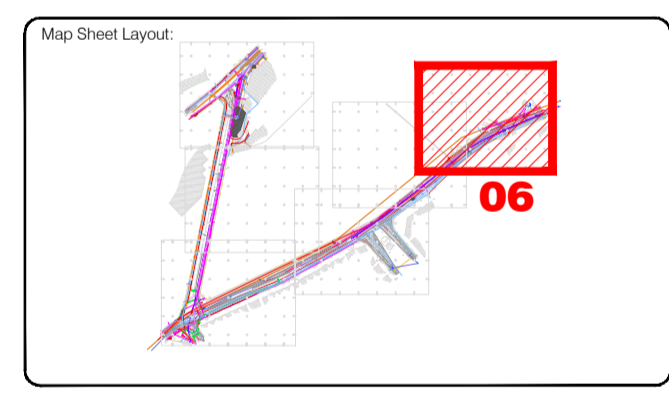
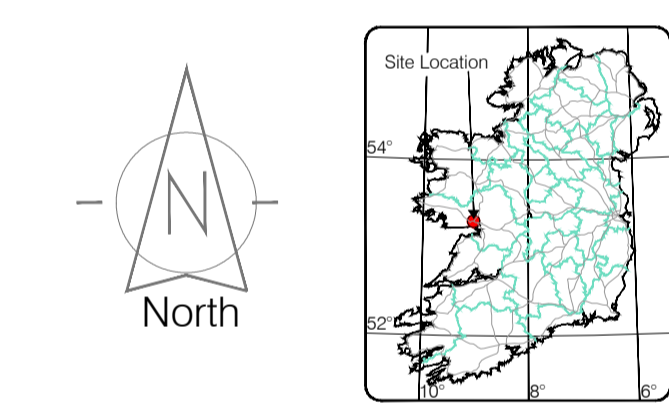

Drawn by: MSL	Date: September 2018	Drawn by: Main Head
Drawn by: DP	Date: 16.10.2018	Grid System: Irish National Grid (ITM)
Checked by: DS	Date: 16.10.2018	

No.	Date	Revisions
3	16.10.2018	First Drawing

murphy SURVEYS
GLOBAL CONSULTING SURVEYORS

Topographic surveys, Measured Building Surveys, Setting Out, As-Built Surveys, Hydrographic Surveys, Legal Mapping, Pipeline Surveys, Services Location, Ground Penetrating Radar, Laser Scanning, Aerial Photography

Kildare Cork Belfast Glasgow London

Head Office
Global House
Kilcullen Business Campus
Kilcullen Co. Kildare
Ireland

Phone: (+353) 045 484040
Fax: (+353) 045 484004
Email: info@murphysurveys.ie

Client: Punch Consulting Engineers Limerick

Project: Crown Square Development

Date: 16.10.2018 **Scale:** 1:250@A1

Description: Utility Survey - sheet 6 of 6

Drawing Number: MSL26811-U

© Copyright 2017 MURPHY SURVEYS LTD

The orange line, as shown, on this particular drawing and bounding the entire of the utility survey area is merely for the purpose of indicating the extent of the area that was surveyed. It must not be taken as being commensurate with the extents of the entire of the plot of ground that the Client may own (or not). In order to establish the ownership of the survey area Murphy Surveys do advise consulting with your Client and their legal team.

Appendix C Site Visit Images



Image 1: Existing construction on site (abandoned in 2008)



Image 2: Access ramp to basement excavation



Image 3: Exposed rock in excavation on Eastern side of the site



Image 4: Foundations built prior to project being abandoned in 2008



Image 5: Ponding water on existing foundations

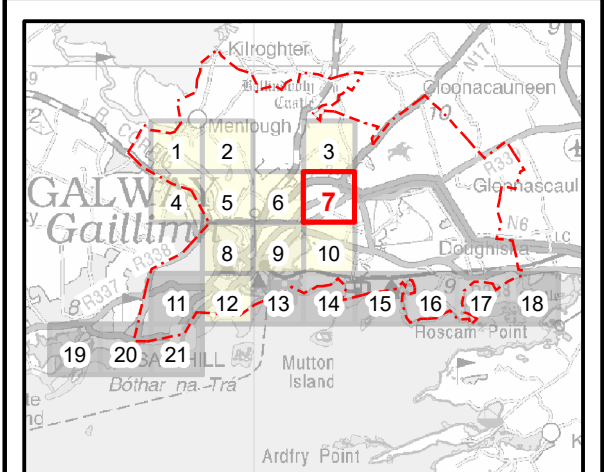
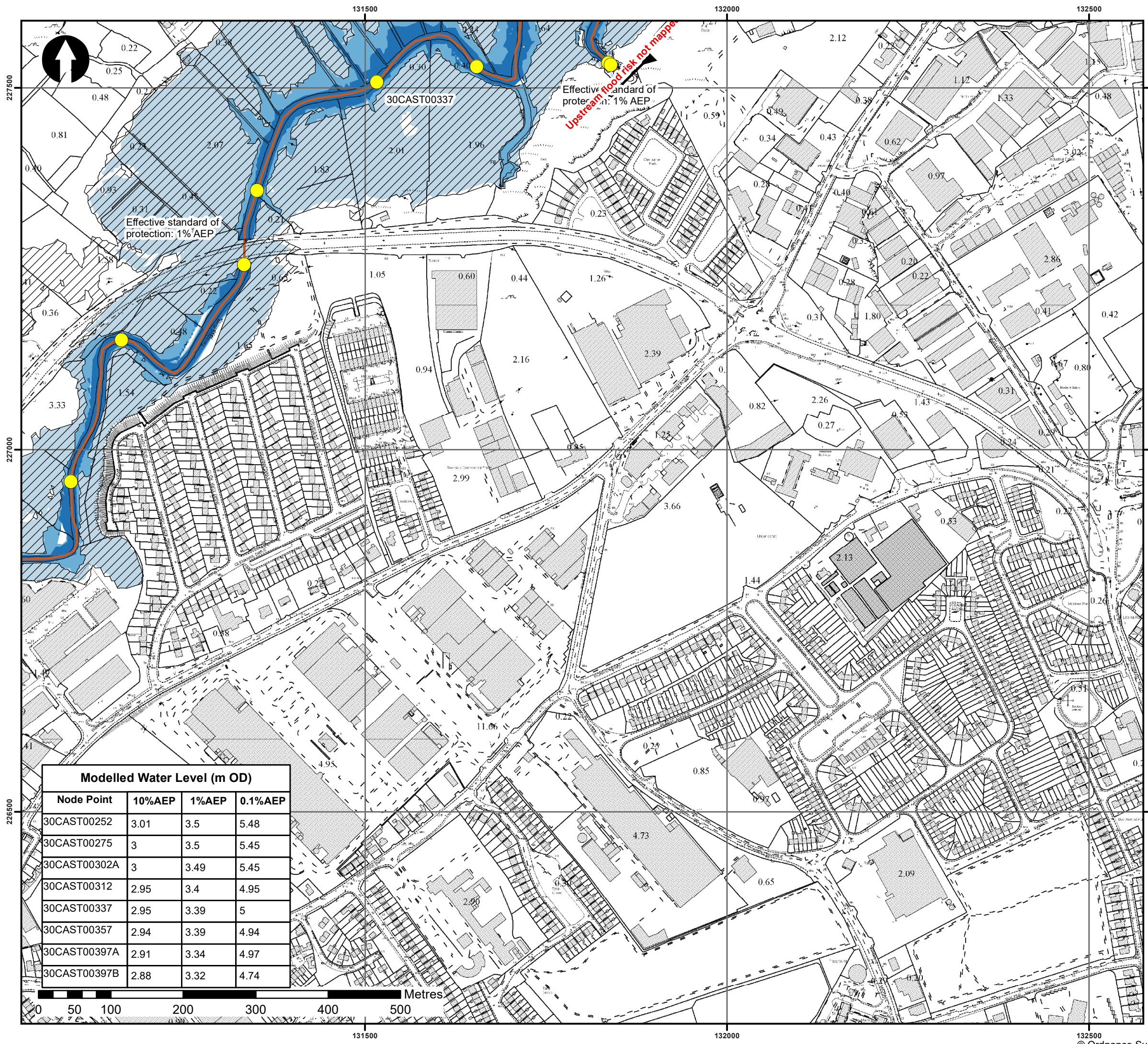

Image 6: Retaining wall on South side of basement excavation



Stage 7: Stone wall with railings on South side of site.

Appendix D CFRAMS maps



Grey squares have no extent shown for this suite of flood maps so no maps have been produced.

- AFA Boundary
- Defended Area
- Model Nodes
- Modelled River Centreline
- 10% AEP Fluvial Extent
- 1% AEP Fluvial Extent
- 0.1% AEP Fluvial Extent

IMPORTANT USER NOTE:
 THE FLOWS PRESENTED IN THIS MAP ARE RELEVANT TO THE LOCATION SHOWN ONLY. THEY SHOULD NOT BE USED WITHOUT FIRST REFERRING TO THE HYDRAULIC MODELLING REPORT TO UNDERSTAND THE CONTEXT OF THE HYDROLOGY AT THE SITE.

THE VIEWER OF THIS MAP SHOULD REFER TO THE DISCLAIMER, GUIDANCE NOTES AND CONDITIONS OF USE THAT ACCOMPANY THIS MAP.

Modelled Water Level (m OD)			
Node Point	10%AEP	1%AEP	0.1%AEP
30CAST00252	3.01	3.5	5.48
30CAST00275	3	3.5	5.45
30CAST00302A	3	3.49	5.45
30CAST00312	2.95	3.4	4.95
30CAST00337	2.95	3.39	5
30CAST00357	2.94	3.39	4.94
30CAST00397A	2.91	3.34	4.97
30CAST00397B	2.88	3.32	4.74

OPW
 Oifig na nOibreacha Poiblí
 The Office of Public Works

The Office of Public Works
 Jonathan Swift Street
 Trim
 Co. Meath

JBA
 consulting

JBA Consulting
 24 Grove Island
 Corbally
 Limerick, Ireland

WESTERN
CFRAM
STUDY
 CATCHMENT FLOOD RISK
 ASSESSMENT AND MANAGEMENT

Map: Galway City Flood Extent		Final
Map Type: Flood Extent		
Map Area: HPW	Source: Fluvial	Scenario: Current
Drawn by: KF	Date: Dec 2017	Scale: 1:5,000
Checked by: TS	Date: Dec 2017	
Approved by: JC	Date: Dec 2017	Original @ A3
Map No: W30GLW_EXFCD_F4_07		Sheet: 7 of 21

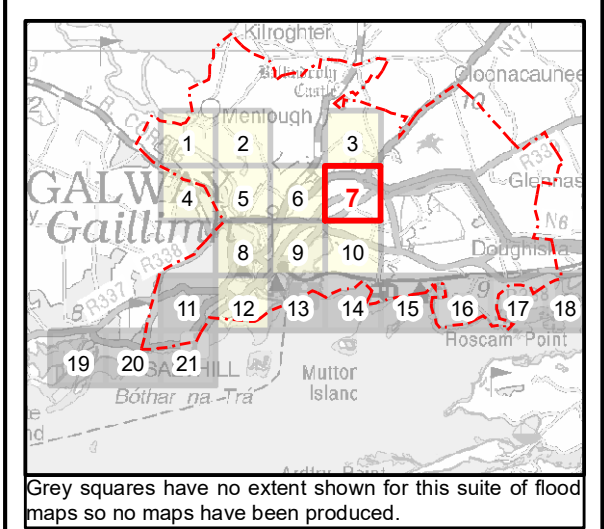
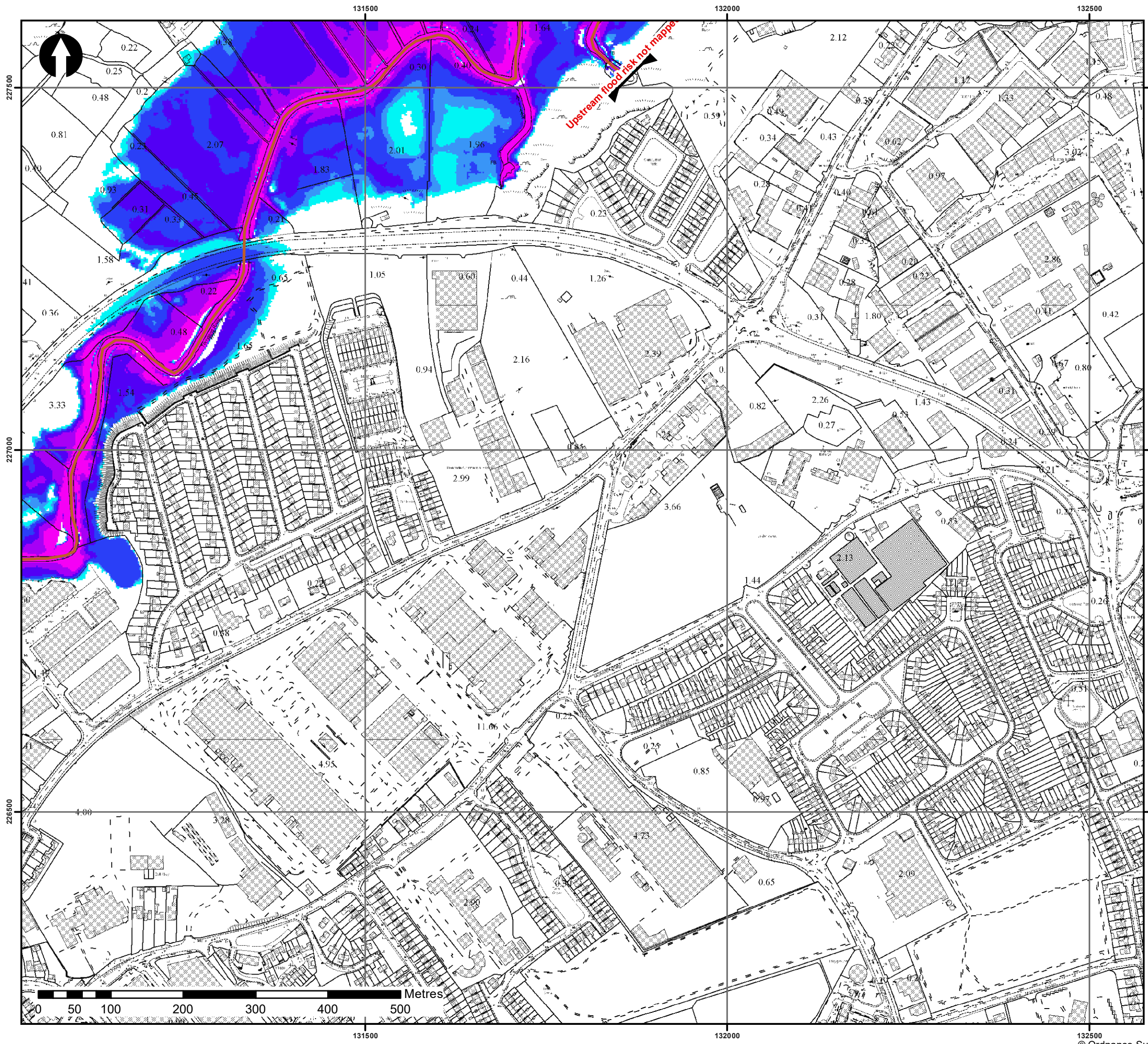

- AFA Boundary
- Modelled River Centreline

**0.1% AEP
Flood Depth (m)**

- 0 - 0.25
- 0.25 - 0.5
- 0.5 - 1.0
- 1.0 - 1.5
- 1.5 - 2.0
- > 2.0

IMPORTANT USER NOTE:
THE VIEWER OF THIS MAP SHOULD REFER TO THE DISCLAIMER, GUIDANCE NOTES AND CONDITIONS OF USE THAT ACCOMPANY THIS MAP.

OPW
Oifig na nOibreacha Poblaithe
The Office of Public Works

The Office of Public Works
Jonathan Swift Street
Trim
Co. Meath

JBA
consulting

JBA Consulting
24 Grove Island
Corbally
Limerick, Ireland

WESTERN
CFRAM
STUDY
CATCHMENT FLOOD RISK
ASSESSMENT AND MANAGEMENT

Map: Galway City Flood Depth (0.1% AEP)		Final
Map Type: Flood Depth (0.1% AEP)		
Map Area: HPW	Source: Fluvial	Scenario: Current
Drawn by: KF	Date: May 2017	Scale: 1:5,000
Checked by: TS	Date: May 2017	Original @ A3
Approved by: JC	Date: May 2017	
Map No: W30GLW_DPFC001_F1	Sheet: 7 of 21	

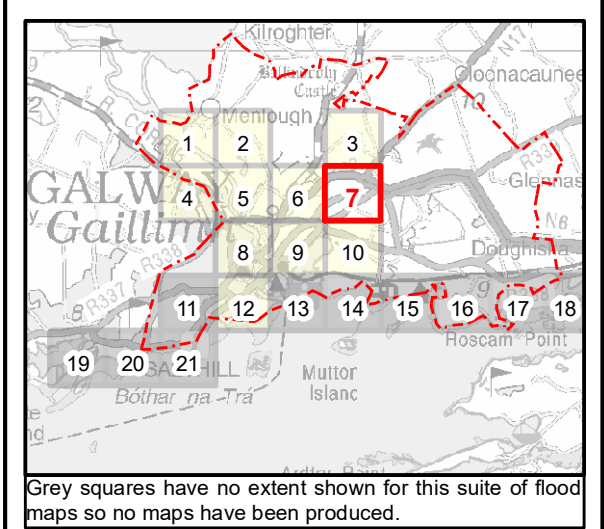
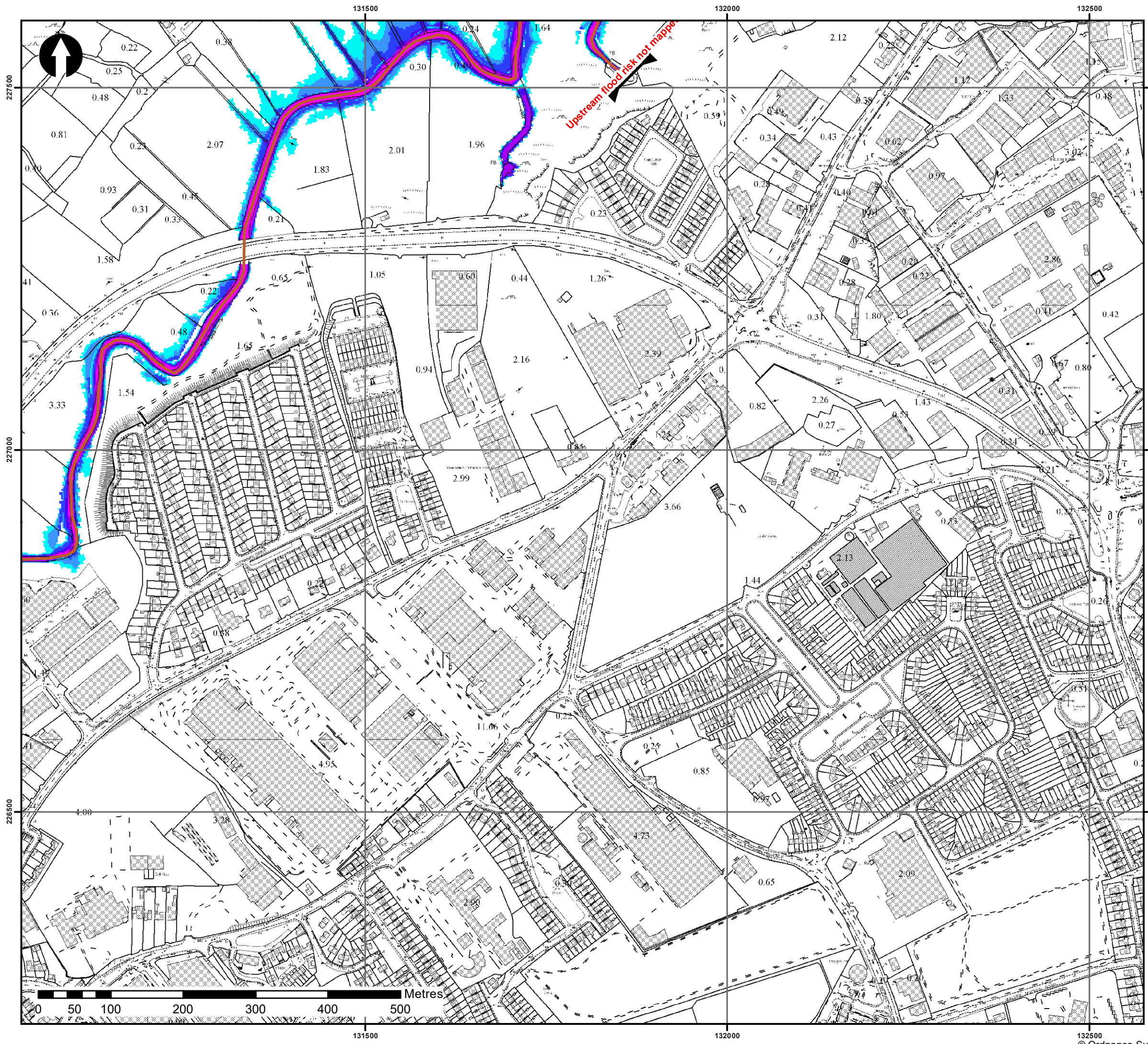

Grey squares have no extent shown for this suite of flood maps so no maps have been produced.

- AFA Boundary
- Modelled River Centreline

**1% AEP
Flood Depth (m)**

- 0 - 0.25
- 0.25 - 0.5
- 0.5 - 1.0
- 1.0 - 1.5
- 1.5 - 2.0
- > 2.0

IMPORTANT USER NOTE:
THE VIEWER OF THIS MAP SHOULD REFER TO THE DISCLAIMER, GUIDANCE NOTES AND CONDITIONS OF USE THAT ACCOMPANY THIS MAP.



OPW
Oifig na nOibracha Poblí
The Office of Public Works

The Office of Public Works
Jonathan Swift Street
Trim
Co. Meath



JBA
consulting

JBA Consulting
24 Grove Island
Corbally
Limerick, Ireland



WESTERN
CFRAM
STUDY
CATCHMENT FLOOD RISK
ASSESSMENT AND MANAGEMENT

Map: Galway City Flood Depth (1% AEP)		Final
Map Type: Flood Depth (1% AEP)		
Map Area: HPW	Source: Fluvial	Scenario: Current
Drawn by: KF	Date: May 2017	Scale: 1:5,000
Checked by: TS	Date: May 2017	Original @ A3
Approved by: JC	Date: May 2017	
Map No: W30GLW_DPFC010_F1	Sheet: 7 of 21	

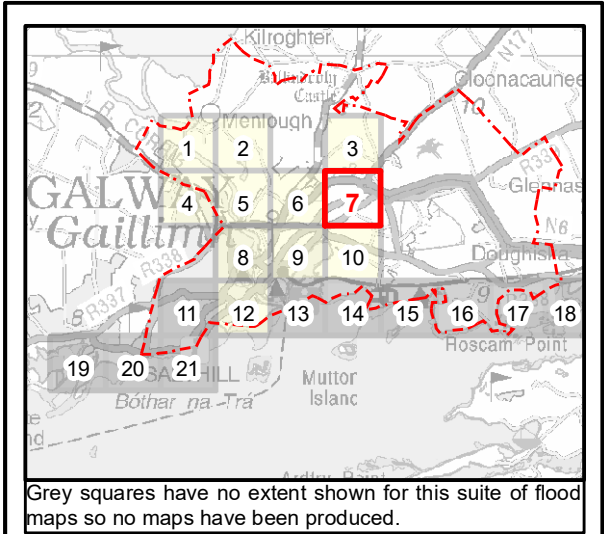
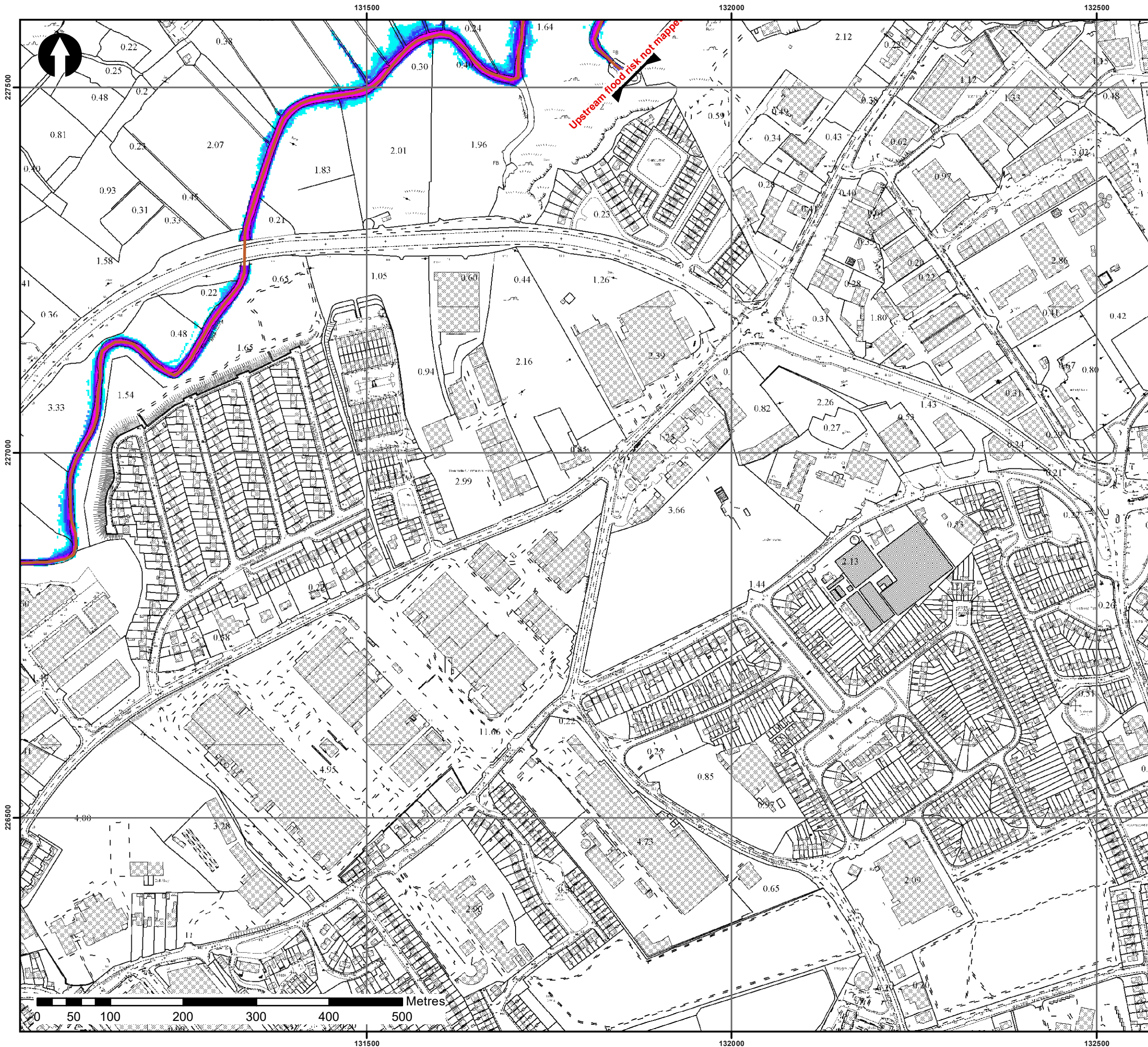

Grey squares have no extent shown for this suite of flood maps so no maps have been produced.

- AFA Boundary
- Modelled River Centreline

**10% AEP
Flood Depth (m)**

- 0 - 0.25
- 0.25 - 0.5
- 0.5 - 1.0
- 1.0 - 1.5
- 1.5 - 2.0
- > 2.0

IMPORTANT USER NOTE:
THE VIEWER OF THIS MAP SHOULD REFER TO THE DISCLAIMER, GUIDANCE NOTES AND CONDITIONS OF USE THAT ACCOMPANY THIS MAP.



OPW
Óifig na nOibríochtaí Poiblí
The Office of Public Works

The Office of Public Works
Jonathan Swift Street
Trim
Co. Meath



JBA
consulting

JBA Consulting
24 Grove Island
Corbally
Limerick, Ireland



WESTERN
CFRAM
STUDY
CATCHMENT FLOOD RISK
ASSESSMENT AND MANAGEMENT

Map: Galway City Flood Depth (10% AEP)		Final
Map Type: Flood Depth (10% AEP)		
Map Area: HPW	Source: Fluvial	Scenario: Current
Drawn by: KF	Date: May 2017	Scale: 1:5,000
Checked by: TS	Date: May 2017	Original @ A3
Approved by: JC	Date: May 2017	
Map No: W30GLW_DPFC100_F1	Sheet: 7 of 21	

Appendix E Existing Services

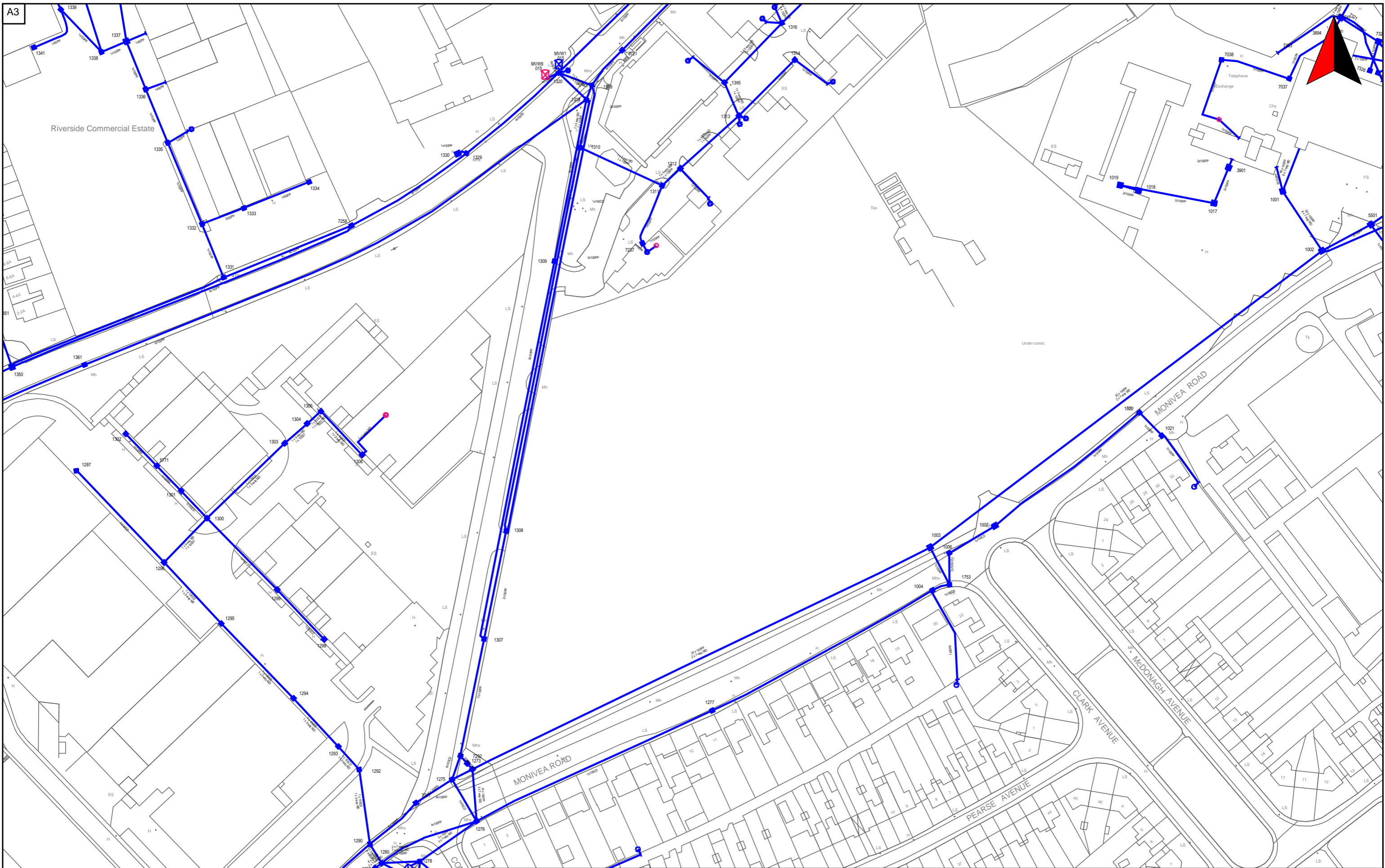

PLANT REQUESTED FROM eircom emaps CBYD SERVICE

<https://cbyd.emaps.eircom.ie/>

Scale: 1:1500

Date
20/06/2018

Irish National Grid Co-Ordinates
Centre XY: 131896 m, 226815 m

emaps CBYD



Ordnance Survey Ireland Licence No EN 0007904
Copyright Ordnance Survey Ireland and Government of Ireland

THE INFORMATION IN THIS DRAWING IS CONFIDENTIAL AND SHOULD NOT BE DISCLOSED TO ANY THIRD PARTY WITHOUT THE EXPRESS WRITTEN CONSENT OF eircom LTD. THE DRAWING IS NOT TO BE PHOTOCOPIED OR REPRODUCED IN ANY WAY

THE INFORMATION GIVEN IS COMPILED FROM RECORDS AND IS BELIEVED TO BE CORRECT. THERE MAY, HOWEVER, BE DEPARTURES FROM THE COURSE[S] AND DEPTH[S] SHOWN OR INDICATED. THERE MAY ALSO BE ITEMS OF eircom PLANT OF WHICH NO RECORDS ARE HELD. THE INFORMATION IS GIVEN WITHOUT PREJUDICE TO THE LEGAL RIGHTS OF eircom LTD. TO COMPENSATION SHOULD eircom PLANT BE DAMAGED.



TITLE:
20180619-010_A0

COLOUR CODE:
 BLACK - 38KV & HIGHER VOLTAGE OVERHEAD LINES
 GREEN - MV(10KV/20KV) OVERHEAD LINES
 BLUE - LV (400V/230V) OVERHEAD LINES
 CYAN - 38KV & HIGHER VOLTAGE UNDERGROUND CABLE ROUTES
 RED - MV/LV (10KV/20KV/400V/230V) UNDERGROUND CABLE ROUTES

DATE: 19-Jun-2018
**** SCALE:** 1:1500
 ** SCALE WHEN PRINTED ON AN A0 PAGE
 XY COORDINATES DISPLAYED IN IRISH GRID COORDINATE SYSTEM
 Maps reproduced by permission:
 Ordnance Survey Ireland Licence No. EN022375-15
 Copyright Ordnance Survey Ireland Government of Ireland

WARNING
 THIS MAP INDICATES THE APPROXIMATE LOCATION OF ESB TRANSMISSION (400KV, 220KV, 110KV, 38KV) AND DISTRIBUTION (20KV, 10KV, 230V/400V) UNDERGROUND CABLES AND OVERHEAD LINES IN THE GENERAL AREA OF THE PROPOSED WORKS. ESB NETWORKS TAKES NO RESPONSIBILITY FOR THE ACCURACY OR COMPLETENESS OF THE MAP. IT IS THE USER'S RESPONSIBILITY TO INDEPENDENTLY VERIFY THE INFORMATION AND THE LOCATION OF UNDERGROUND CABLES AND OVERHEAD LINES. LOW VOLTAGE (230V/400V) SERVICE CABLES (E.G. HOUSE SERVICES, FACTORY/SHOP SERVICES, PUBLIC LIGHTING LAMP SERVICES, ETC) ARE NOT INCLUDED BUT THEIR PRESENCE SHOULD BE ANTICIPATED. THE DEPTHS OF UNDERGROUND CABLES MUST NEVER BE ASSUMED. ADDITIONAL MORE DETAILED INFORMATION IS AVAILABLE FOR HIGH VOLTAGE TRANSMISSION UNDERGROUND CABLES (38KV, 110KV, 220KV, 400KV) FROM THE LOCAL ESB NETWORKS TRANSMISSION REPRESENTATIVE. SEE ATTACHED LIST FOR CONTACT DETAILS OR CALL 1850 372 757. NO WORK SHOULD BE CARRIED OUT IN THE VICINITY OF 38KV OR HIGHER VOLTAGE UNDERGROUND CABLES WITHOUT PRIOR CONSULTATION WITH ESB NETWORKS. BEFORE ANY MECHANICAL EXCAVATION IS UNDERTAKEN, THE ACTUAL LOCATION OF ALL UNDERGROUND ELECTRICITY CABLES MUST BE ESTABLISHED AND VERIFIED ON THE SITE USING:
 (A) UP-TO-DATE MAP RECORDS; (B) CABLE LOCATOR EQUIPMENT OPERATED IN BOTH POWER AND RADIO MODES; (C) CAREFUL HAND DIGGING OF TRIAL HOLES USING 'SAFE DIGGING PRACTICE'. REFER ALSO TO IHA CODE OF PRACTICE FOR AVOIDING DANGER FROM UNDERGROUND SERVICES'. ESB TAKES NO RESPONSIBILITY FOR AND SHALL BEAR NO LIABILITY, HOWSOEVER ARISING, IN RELATION TO ANY DAMAGE, INJURY/DEATH OR LOSS OF SUPPLY AS A RESULT OF DAMAGE OR INTERFERENCE WITH ITS NETWORKS.

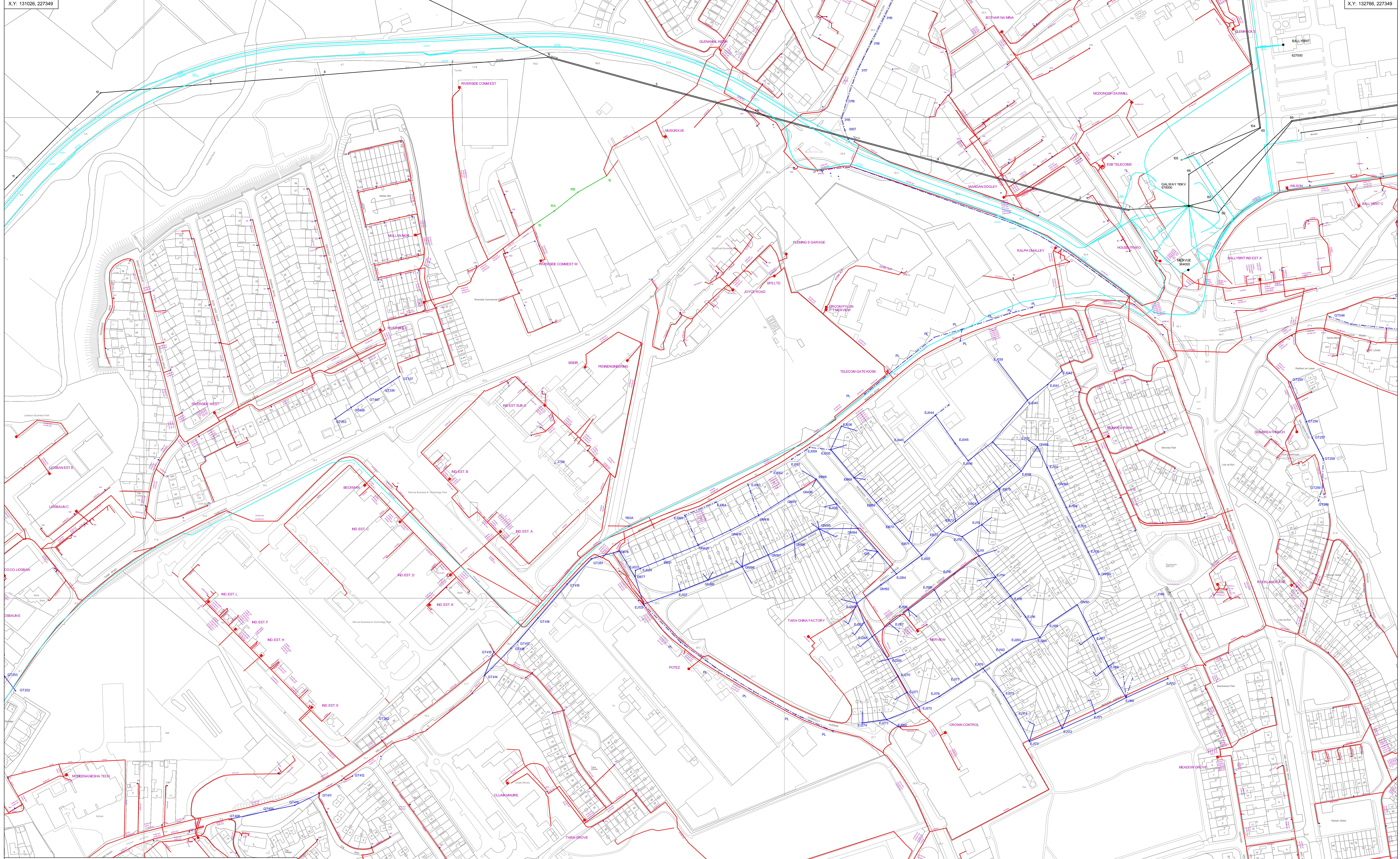

PLEASE NOTE THAT THERE ARE: HIGH VOLTAGE (38KV AND HIGHER VOLTAGES) OVERHEAD LINES AND UNDERGROUND CABLES ON THIS MAP. IF YOU INTEND WORKING, OR UNDERTAKING DEVELOPMENT WITHIN A CORRIDOR EXTENDING 40 METRES ON EITHER SIDE OF ANY HIGH VOLTAGE OVERHEAD LINES OR WITHIN A CORRIDOR EXTENDING 5 METRES ON EITHER SIDE OF ANY HIGH VOLTAGE UNDERGROUND CABLES YOU MUST CONTACT THE DESIGNATED PARTIES (PLEASE SEE ENCLOSED SHEET) IN ADVANCE OF THE WORKS

X,Y: 132766, 227349

X,Y: 132766, 226195

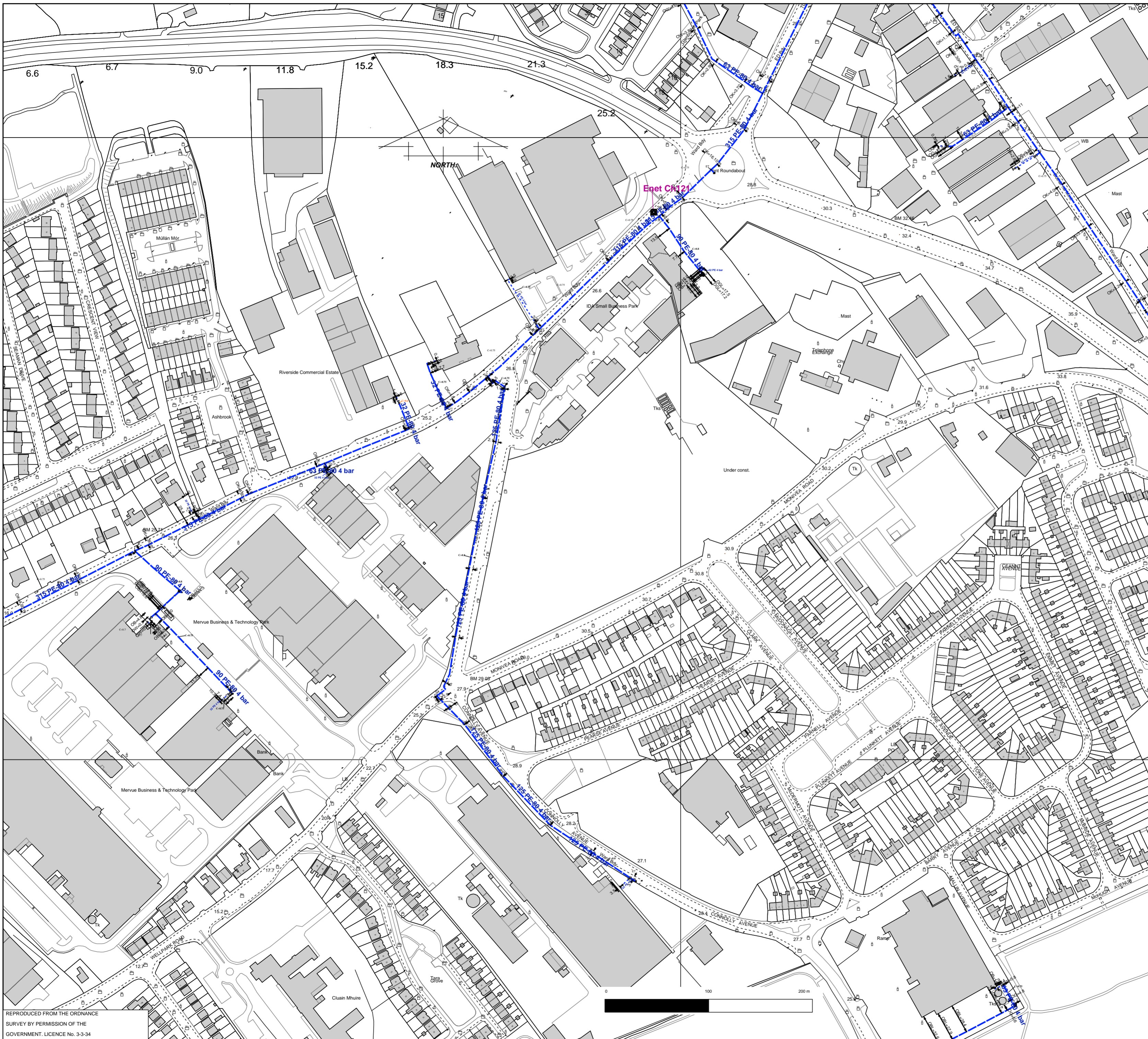

Important Safety Notice:
 Damage to gas pipelines can result in serious injury or death. Gas network information is provided as a general guide. The exact location and depth of medium or low pressure distribution gas pipes must be verified on site by carrying out necessary investigations, including, for example, hand digging trial holes along the route of the pipe.
 Service pipes are not generally shown but their presence should always be anticipated.

High pressure transmission pipelines are shown in red. If a transmission pipeline is identified within 10m of any intended excavations then work must not proceed before GNI has been consulted. The true location and depth of a transmission pipeline must be verified on site by a representative of GNI. Contact can be made through 1850 427 747.

All work in the vicinity of the gas network must be completed in accordance with the current edition of the Health & Safety Authority publication, Code of Practice For Avoiding Danger From Underground Services which is available from the Health and Safety Authority (1890 289 389) or can be downloaded at www.hsa.ie.

Legal Notice:
 Gas Networks Ireland (GNI) and its affiliates, accept no responsibility for the accuracy of any information contained in this document including data concerning location and technical designation of the gas distribution and transmission network (the Information). The Information should not be relied on for accurate distance or depth of cover measurements.

Any representations and warranties, express or implied, are excluded to the fullest extent permitted by law. No liability shall be accepted for any loss or damage including, without limitation, direct, indirect or consequential loss, arising out of or in connection with the use or re-use of the Information.

- Aurora Telecom Fibre Optic Cable
- Aurora Telecom Duct
- Aurora Telecom Sub-duct
- Aurora Telecom Inserted Gas Pipe

Contact Aurora Telecom on 1850-427-399 or (01)203-0120.

- Transmission Pipe (High Pressure)
- Transmission Pipe (Construction Issue)
- Distribution Pipe (Medium Pressure)
- Distribution Pipe (Low Pressure)
- Service Pipe (Medium Pressure)
- Service Pipe (Low Pressure)
- Strategic Pipe (Medium Pressure)
- Strategic Pipe (Low Pressure)
- Inserted Pipe (Medium Pressure)
- Inserted Pipe (Low Pressure)
- Distribution Pipe (Abandoned)

- Cover (depth in meters)
- CP Test Point
- End Cap
- Hot Tap
- Installation
- Valve
- Mains Verification **
- Pressure Monitor
- Protection (Sleeve)
- Protection (Slabbing)
- Reducer
- Service Terminator
- Tee
- Transition

** Please contact GNI on 1850-427747 for specific information.

REPRODUCED FROM THE ORDNANCE SURVEY BY PERMISSION OF THE GOVERNMENT. LICENCE No. 3-3-34

Design Department - DUBLIN	
GAS NETWORK INFORMATION	
Issue:	Punch Consulting Engineers
Location:	Monivea Rd, Mervue, Co. Galway
Plot Date:	19/06/2018
Plotted by:	KOC
Contact:	C Fallon
Scale:	1:2500

Not Archived - Alternative : Network Maintenance Dublin(2015)_Pits Kevin



Legend

Sewer Gravity Mains (Irish Water owned)

Liquid Type

- Combined
- - - Foul
- Overflow
- Unknown

Sewer Gravity Mains (Non-Irish Water owned)

Liquid Type

- Combined
- - - Foul
- Overflow
- Unknown

Sewer Manholes

Manhole Type

- Cascade
- Catchpit
- Hatchbox
- Lamphole
- Standard
- Other; Unknown

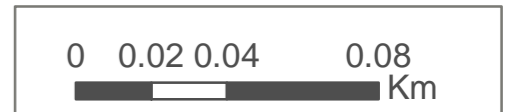

Coordinate System: TM65 Irish Grid
Projection: Transverse Mercator

Scale @ A2:	1:2,000
Drawing No.:	Crown pe FW
Drawn By:	J Sheahan
Checked By:	.
Approved By:	.
Drawn Date	19/06/2018
Checked Date:	.
Approved Date:	.

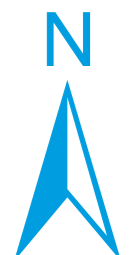

1. No part of this drawing may be reproduced or transmitted in any form or stored in any retrieval system of any nature without the written permission of Irish Water as copyright holder except as agreed for use on the project for which the document was originally issued.

2. Whilst every care has been taken in its compilation, Irish Water gives this information as to the position of its underground network as a general guide only on the strict understanding that it is based on the best available information provided by each Local Authority in Ireland to Irish Water. Irish Water can assume no responsibility for and give no guarantees, undertakings or warranties concerning the accuracy, completeness or up to date nature of the information provided and does not accept any liability whatsoever arising from any errors or omissions. This information should not be relied upon in the event of excavations or any other works being carried out in the vicinity of the Irish Water underground network. The onus is on the parties carrying out excavations or any other works to ensure the exact location of the Irish Water underground network is identified prior to excavations or any other works being carried out. Service connection pipes are not generally shown but their presence should be anticipated.

Water Services Crown Site Monivea Road

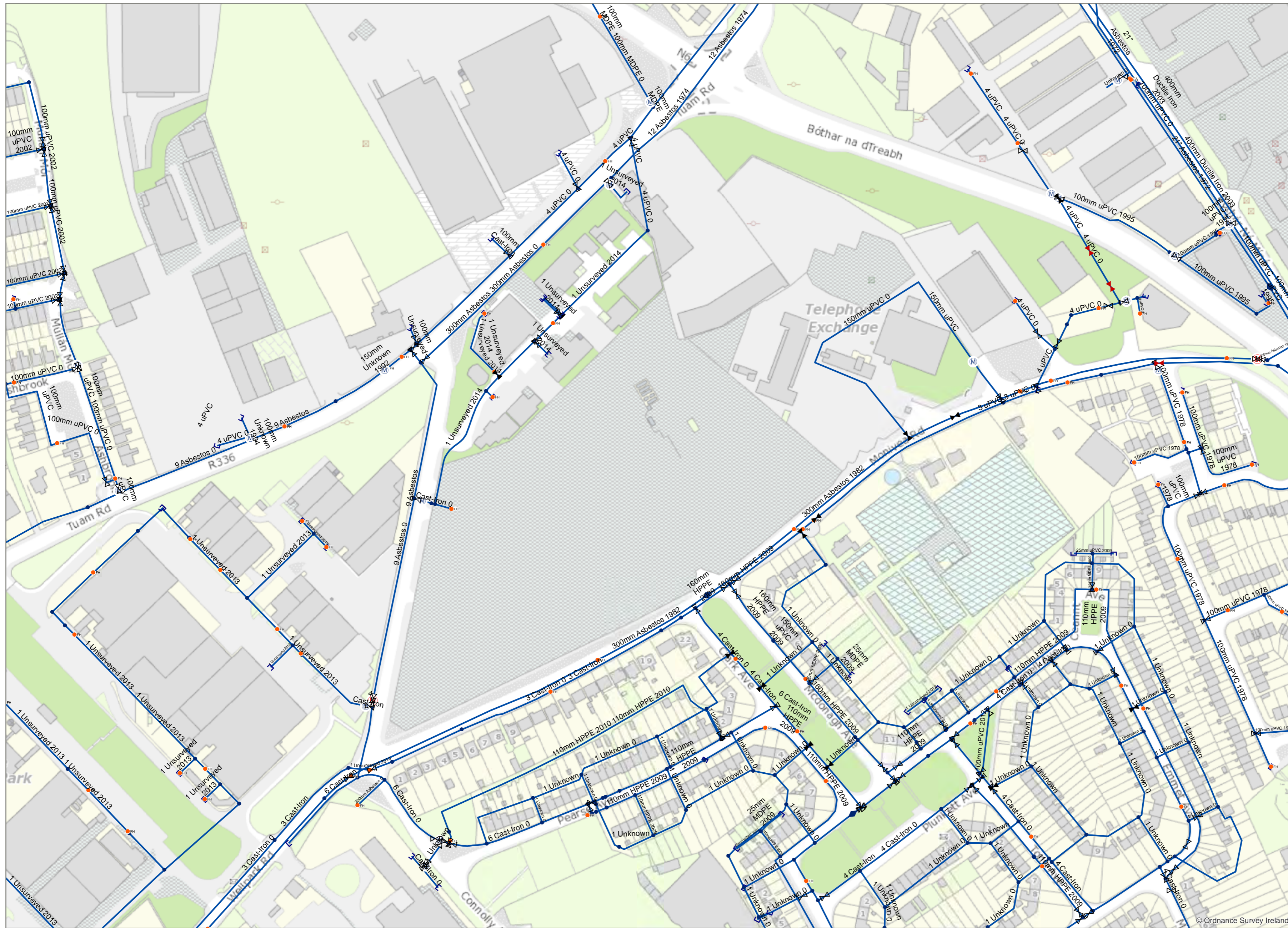

Legend

Water Mains(Irish Water Owned)

Liquid Type

- Untreated
- Potable Water

Water Mains(Non Irish Water Owned)

Liquid Type

- Untreated
- Potable Water

Boundary Valves

Valve Normal Position

- ◀▶ Open
- ◻ Closed
- ◊ Part Closed

Non Boundary Valves

Valve Normal Position

- ◀▶ Open
- ◻ Closed
- ◊ Part Closed

0 0.02 0.04 0.08 Km

Coordinate System: TM65 Irish Grid
Projection: Transverse Mercator

Scale @ A2: 1:2,000

Drawing No.: Crown pe W

Drawn By: J Sheahan

Checked By: .

Approved By: .

Drawn Date 19/06/2018

Checked Date: .

Approved Date: .

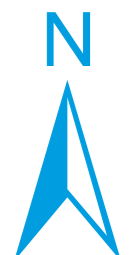

1. No part of this drawing may be reproduced or transmitted in any form or stored in any retrieval system of any nature without the written permission of Irish Water as copyright holder except as agreed for use on the project for which the document was originally issued.

2. Whilst every care has been taken in its compilation, Irish Water gives this information as to the position of its underground network as a general guide only on the strict understanding that it is based on the best available information provided by each Local Authority in Ireland to Irish Water. Irish Water can assume no responsibility for and give no guarantees, undertakings or warranties concerning the accuracy, completeness or up to date nature of the information provided and does not accept any liability whatsoever arising from any errors or omissions. This information should not be relied upon in the event of excavations or any other works being carried out in the vicinity of the Irish Water underground network. The onus is on the parties carrying out excavations or any other works to ensure the exact location of the Irish Water underground network is identified prior to excavations or any other works being carried out. Service connection pipes are not generally shown but their presence should be anticipated.

© Copyright Irish Water

Reproduced from the Ordnance Survey Of Ireland by Permission of the Government. License No. 3-3-34

Map Template Design: kcarroll@water.ie

Water Services Crown Site Monivea Road

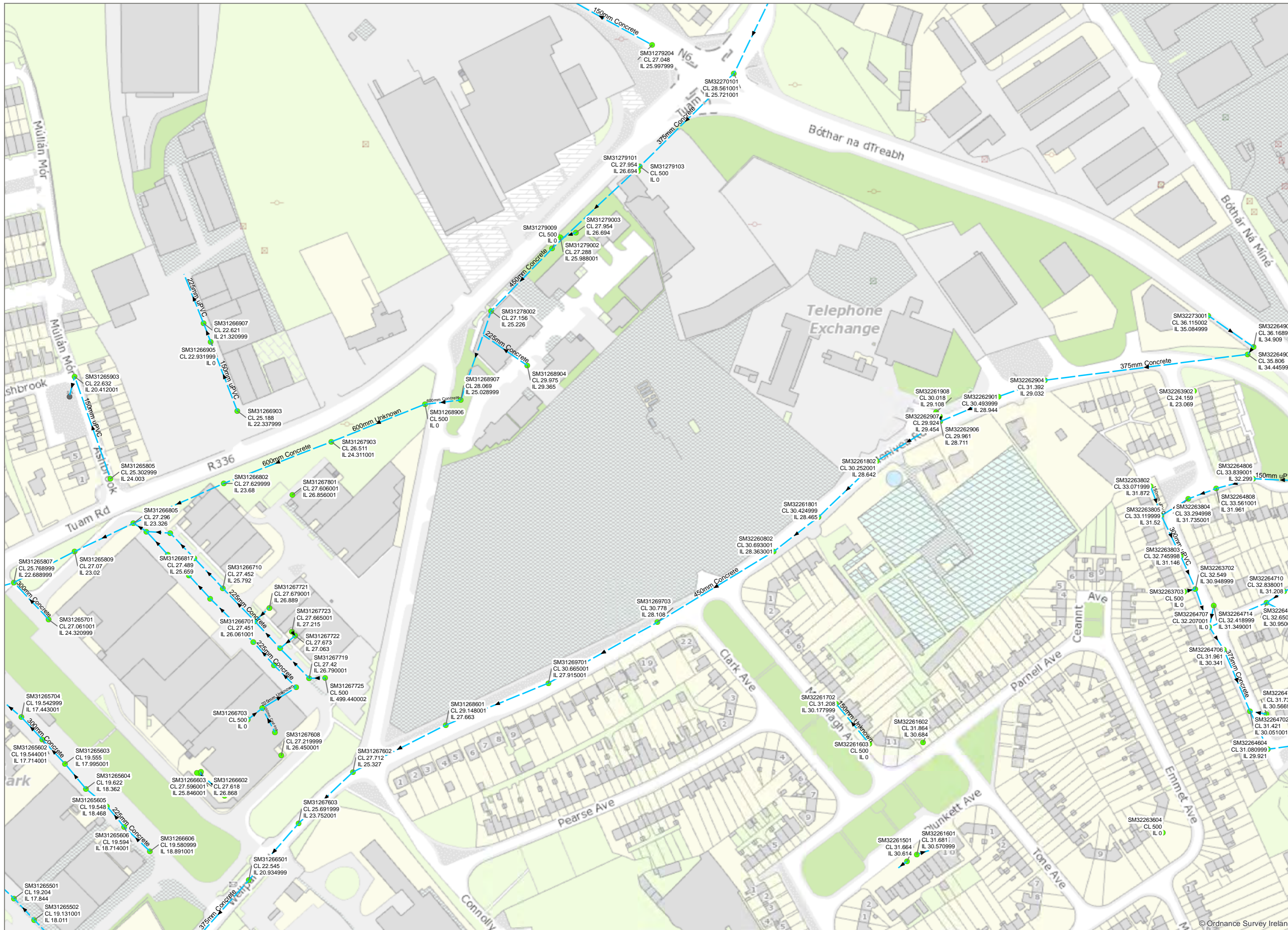

Legend

Liquid Type

Surface

Liquid Type

Surface

Storm Manholes

Manhole Type

Cascade

Catchpit

Hatchbox

Lamphole

Standard

Other; Unknown

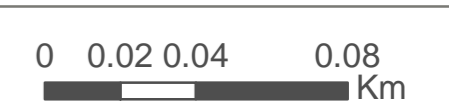

Coordinate System: TM65 Irish Grid
Projection: Transverse Mercator

Scale @ A2:	1:2,000
Drawing No.:	Crown pe SW
Drawn By:	J Sheahan
Checked By:	.
Approved By:	.
Drawn Date	19/06/2018
Checked Date:	.
Approved Date:	.

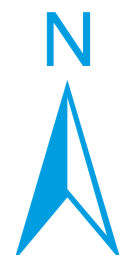

1. No part of this drawing may be reproduced or transmitted in any form or stored in any retrieval system of any nature without the written permission of Irish Water as copyright holder except as agreed for use on the project for which the document was originally issued.

2. Whilst every care has been taken in its compilation, Irish Water gives this information as to the position of its underground network as a general guide only on the strict understanding that it is based on the best available information provided by each Local Authority in Ireland to Irish Water. Irish Water can assume no responsibility for and give no guarantees, undertakings or warranties concerning the accuracy, completeness or up to date nature of the information provided and does not accept any liability whatsoever arising from any errors or omissions. This information should not be relied upon in the event of excavations or any other works being carried out in the vicinity of the Irish Water underground network. The onus is on the parties carrying out excavations or any other works to ensure the exact location of the Irish Water underground network is identified prior to excavations or any other works being carried out. Service connection pipes are not generally shown but their presence should be anticipated.

© Copyright Irish Water

Reproduced from the Ordnance Survey Of Ireland by Permission of the Government. License No. 3-3-34

Map Template Design: kcarroll@water.ie

Water Services Crown Site Monivea Road

